

JETSURF®

MOTORIZED SURFBOARD

USER MANUAL

part

A

version 19-DFI002/EN_part A

models

JETSURF ADVENTURE DFI
JETSURF RACE DFI

DFI

SYMBOLS USED



This symbol is used to mark important warnings which are often ignored by the JetSurf users. Please pay due attention to these warnings. You will thus avoid making frequent user mistakes. These warnings are based on the experience of the JetSurf service technicians. Ignoring these warnings may cause permanent damage to the vessel and its parts.

SAFETY WARNING SYMBOLS

This is the safety alert symbol. It is used to alert you to potential personal injury hazards. Obey all safety messages that follow the symbol to avoid possible injury or death.



DANGER indicates an imminently hazardous situation which, if not avoided, will result in death or serious injury.



WARNING indicates a potentially hazardous situation which, if not avoided, could result in death or serious injury.



CAUTION indicates a potentially hazardous situation which, if not avoided, may result in minor or moderate injury.



NOTICE is used to address practices not related to physical injury. This information could result in damages to the product that are not covered under warranty.

These icons will appear throughout the Owner's Manual.

PLEASE KEEP THIS MANUAL AT A SAFE PLACE AND HAND IT OVER TO A NEW OWNER IF YOU SELL THE JETSURF.

THE MANUAL COMPRISES OF TWO PARTS (Part A and Part B) which form an integral document. The rules and warnings included in one part apply to the other. Therefore always keep both parts with you.

USER MANUAL

Copyright 2019; All rights reserved

JetSurf™ motorized power boards were designed and manufactured by MotosurfWC and Formula 1 engineers to push the limits of motor sports. The power boards created by JetSurf™ are the only motorized water vehicles with the ability to be transported by hand, car, boat or plane (as hand luggage on international/domestic carrier flights). This allows the users of JetSurf™ power boards to travel easily around the world – a unique attribute in comparison to other motorized watercraft.

JetSurf™ parts and components are manufactured by MSR Engines, based in the Czech Republic. The company specializes in the development of combustion engines and specialized electronics.

JetSurf™ power boards are produced in a single factory that uses the highest standards of production technology. Only the finest materials and components currently produced in the European Union are utilized. This comprehensive in-house production allows JetSurf™ to ensure the maximum precision and efficient production. Since 2017 the manufacturer has been an ISO 9001 certificate holder.

JetSurf™ power boards were developed with exceptional effort to minimize environmental impact. Through specialized and the most advanced technology, engineers have reduced the total weight of the JetSurf™ power board and accessories to forty four (44) pounds (twenty kilograms [+20]). JetSurf™ power boards meet homologation (registration for racing) standards for noise emissions, as well as using an internal combustion engine that enforces the Greentech technology and complies with the emission limits set for motor vessels. The complete drive unit is certified and approved by the European Commission and received the European Union label, CE. All this effort toward compliance with international standards has ensured that the power boards are also compliant with North American requirements for personal watercraft.

EPA Emissions Regulations:*

JetSurf motorized surfboards are certified to the United States Environmental Protection Agency (EPA) as conforming to the requirements of the regulations for the control of air pollution from new watercraft engines. This certification is contingent on certain adjustments being set to factory standards. §1068.101(b)(1) prohibits tampering, removal or rendering inoperative any device installed onto the engine in compliance with EPA regulations prior to sale and delivery to, as well as after the sale to, the ultimate purchaser of the product.

Maintenance, replacement, or repair of the emission control devices and systems may be performed by any marine engine repair establishment or individual.

Emission Control Information is printed onto the Engines as permanent evidence of EPA certification.

The information contained in this User Manual represents the most up-to-date product data available at the time of printing. Because JetSurf™ is committed to continuous product improvements and advancement of technology, the company reserves the right to change the product, components, specifications or other aspects of the JetSurf™ motorized power board without advance notice or a requirement to equip previously produced JetSurf™ motorized power boards with these changes. You can find current upgrades on the JetSurf™ websites (www.jetsurf.com). Check this website regularly.

This User Manual for Owners or Operators (hereafter referred to as the “User Manual”) cannot anticipate every circumstance involved in owning or operating the motorized power board. JetSurf™ strongly encourages owners and operators to regularly review the U.S. Coast Guard website (www.uscg.mil) or the relevant coast guard and/or authority regulating the laws pertaining to the use of personal watercraft with particular attention to information provided for personal watercraft. Also check JetSurf™ company's website (www.jetsurf.com) for updates and product information.

JetSurf™ provides the following information in the expectation of long and enjoyable ownership of this JetSurf™ motorized power board.

* Valid for the USA

This manual will help you to operate your vessel safely and easily. It contains a detailed description of the vessel, its supplied or built-in accessories, systems and information about their operation and maintenance. Please read it carefully and learn about the vessel before you start using it.

Do not set out on a ride until the conditions (wind force and wave height) correspond to the construction category of your vessel and make sure you are able to safely control the vessel in these conditions.

This user manual does not include detailed maintenance or repair instructions. If you experience any problems, contact the Authorized Dealer or manufacturer of the vessel. If you have the maintenance manual, please follow it during the vessel maintenance.

Maintenance, fixing and adjustments of the vessel can only be made by trained and qualified persons. Any adjustments which might affect the safety characteristics of the vessel have to be checked, implemented and documented by a competent person. The manufacturer of the vessel cannot be held responsible for any adjustments not approved by it.

In some countries it is required to have qualification or certificate to control a vessel or some other special regulations might apply.

Always duly maintain your motorized power board and be aware it will wear with time and as a result of demanding operation or bad handling.

Each vessel, regardless how hard-wearing it is, can suffer severe damage if used incorrectly. This is incompatible with its safe use. Always adapt the speed and course of the vessel to the conditions (wind force and wave height).

The person controlling the vessel must use suitable swimming aids described in the chapter PERSONAL SWIMMING AIDS in this manual. It is necessary to point out that in some countries the law requires wearing swimming aids under all circumstances while using the JetSurf™ and is therefore necessary to comply with these national legislations.

PLEASE KEEP THIS MANUAL AT A SAFE PLACE AND HAND IT OVER TO A NEW OWNER IF YOU SELL THE VESSEL.

This user manual comprises of two parts. Any reference to the user manual always means both its parts.

TABLE OF CONTENTS

SYMBOLS USED	3	STAGE ONE – ICU activation	32
SAFETY WARNING SYMBOLS	3	STAGE TWO – engine start	32
USER MANUAL	4	BRIEF DESCRIPTION OF STARTING	33
1A IDENTIFICATION PLATES AND WARNINGS	7	STARTING FROM THE BANK (IN SHALLOW WATER)	33
IDENTIFICATION PLATE OF THE VESSEL ..	7	STARTING IN DEEP WATER O R AFTER FALLING DOWN	35
CRAFT IDENTIFICATION NUMBER (CIN) ..	7	JETSURF CONTROL - THROTTLE	35
ENGINE IDENTIFICATION PLATE	7	JETSURF CONTROL - TURNING	35
WARNINGS	8	JETSURF CONTROL - RIDING	35
2A SAFETY MATTERS	11	JETSURF CONTROL – STOPPING/FALLING ..	36
DEFINITION	12	AFTER THE RIDE	36
GENERAL COMMON SENSE	12	A BRIEF LIST OF TASKS TO BE DONE BEFORE THE RIDE A BRIEF LIST OF THE TASKS TO BE DONE AFTER THE RIDE ...	37
CARBON MONOXIDE	13	WATER REMOVAL FROM THE FLOODED ENGINE	38
ENGINE PREPARATION	14	4A STORAGE	40
CLOTHING	15	SHORT-TERM STORAGE	40
PERSONAL FLOTATION DEVICES (PFDs) ..	15	LONG-TERM STORAGE	40
LAW ENFORCEMENT	16	5A TRANSPORT	41
UNDER THE INFLUENCE	16	AIR TRANSPORT	41
REGISTRATION	16	TRANSPORT TO SERVICING	41
SPEEDING/NOISE	16	6A MAINTENANCE	42
ELECTRONIC DEVICES	16	SURFACE MAINTENANCE	42
JUMPS ON JETSURF	16	MAINTENANCE OF TECH. EQUIPMENT	42
REPORTING ACCIDENTS AND INSURANCE ..	17	ENGINE MAINTENANCE	42
REFUSE AND POLLUTION	17	SPARK PLUG	42
OTHER SAFETY MATTERS	18	SPARK PLUG REPLACEMENT	43
SAFE OPERATION ON THE WATER	19	CHECK OF SPARK PLUG	43
GENERAL PRUDENTIAL RULE	19	MAINTENANCE OF BILGE PUMP	45
GENERAL EXPECTATIONS	19	MAINTENANCE OF EXH. SILENCER	45
3A RIDE	22	TABLE OF REGULAR MAINTENANCE	46
BEFORE YOU START	22	7A WARRANTY	47
STAND AND ITS UNFOLDING	22	8A TROUBLESHOOTING	51
FINS	22	SIGNALLING OF ICU FAULTS	52
STRAPS	24	CHECK OF THE SPARK PLUG AND TIMING SENSOR FUNCTION	53
TUBES	24	AUTHOR. DEALERS	62
ELECTRIC CONNECTIONS	24		
CONTROL HANDLE	24		
CHARGING OF THE ICU BATTERY	25		
FUEL TOP-UP	28		
LUBRICATION	29		
START AND FIRST RIDE	31		
JETSURF STARTING	32		

1A IDENTIFICATION PLATES AND WARNINGS

IDENTIFICATION PLATE OF THE VESSEL

The identification plate of the vessel is attached in the motor compartment. Information that you can not find on this plate are written in respective category of the manual.

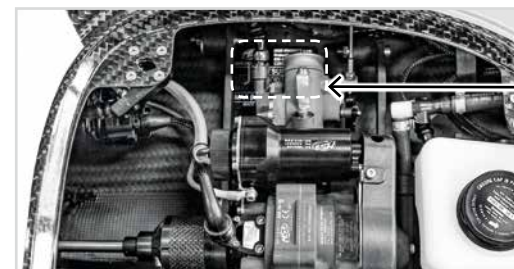

CRAFT IDENTIFICATION NUMBER (CIN)

The craft identification number is situated on the starboard near the stern.



CZ-MSR □□□□□□□□
or for the USA
JSU □□□□□□□□

ENGINE IDENTIFICATION PLATE

The engine serial number and information concerning the exhaust fume emission control is laser-marked in the engine.

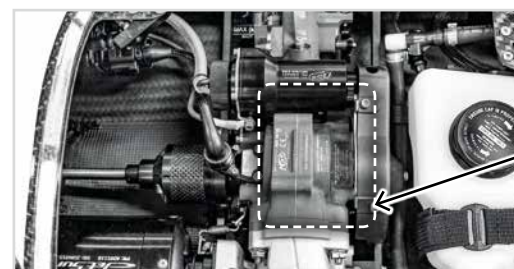

MSR Engines s.r.o. **MSRNG 100**
MSR **CE** 2371
DATE OF MFG: 01/19
SN : FD 1000 005999 9
EMISSION CONTROL INFORMATION
FAMILY: KMSEM0.090E2
DISP: 0.09 liter
MAX. ENGINE POWER: 7.2 kW
THIS ENGINE COMPLIES WITH 2019 U.S. EPA EXHAUST EMISSION REGULATIONS & EVAP STD'S USING CERTIFIED COMPONENTS
READ OWNER'S MANUAL FOR MORE DETAILS

IDENTIFICATION PLATES AND WARNINGS

WARNINGS

Before using this vehicle, read the following plates. If you have any questions, consult a sales representative of JetSurf™.

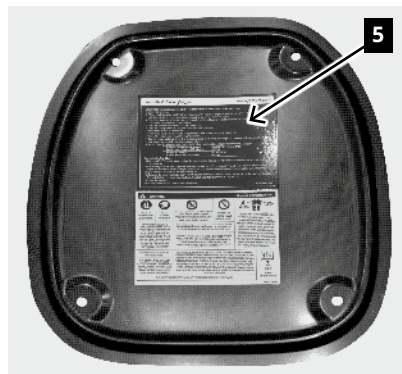
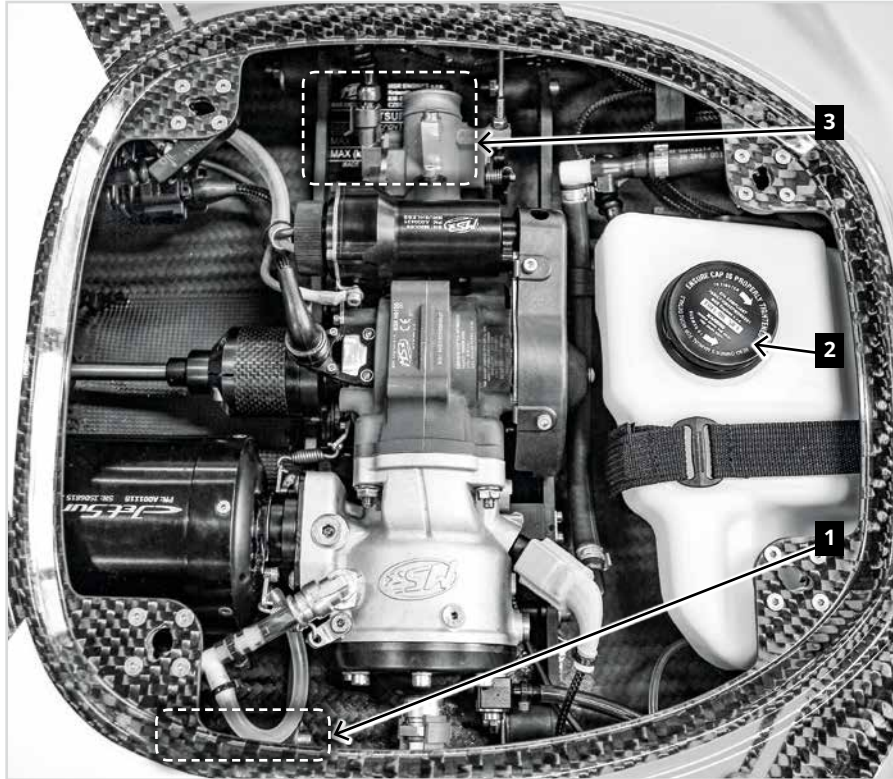

IDENTIFICATION PLATES AND WARNINGS

- 1 – sticker MSR 0116/M2-EN situated on the spark plug boot
- 2 – warning on the tank
- 3 – warning on the ICU
- 4 – sticker MSR 0717/H1-EN situated at the snorkel
- 5 – stickers MSR 0616/D1-EN and MSR 0316/D2-EN situated on the engine complement hood

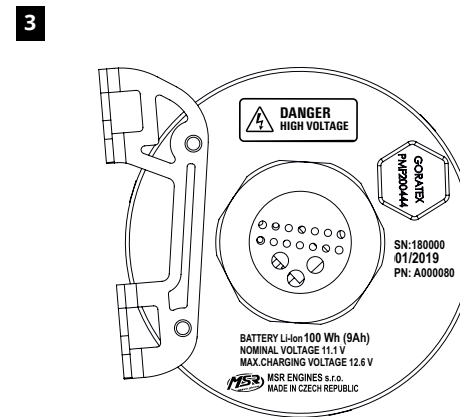
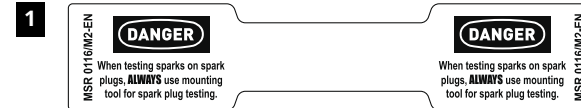

www.jetsurf.com **JETSURF** MOTORIZED SURFBOARD  Read the manual!

THE CHECKLIST FOR THE ENGINE AND THE CONTROL UNIT THAT NEEDS TO BE PERFORMED BEFORE EVERY RIDE:







- 1) Charge the batteries in the ICU.
- 2) Fill the tank with premixed petrol (min. octane rating 95 – Natural 95, Super 95) and oil to the ratio of 50:1 (10 litres of petrol : 0.2 litres of oil). Use only oil intended for two-stroke jet-ski watercrafts or two-stroke combustion engines.
- 3) Check the connection of the hoses to the cooling system of the engine and the hose to the cooling system of the exhaust, both visually and applying a slight pulling force.
- 4) Check the connection of all the control unit connectors.
- 5) Check the spark plug. Check the spark plug boot and push it down if necessary. Check the spark plug boot holder so that it could not get loose during the ride.
- 6) Inspect the throttle control and fuel system.
- 7) Before riding (once a day is sufficient), spray the engine parts with MOTOREX INTACT MX 50 (oil).
- 8) Start the engine, check the engine operation and throttle control. The engine can run without cooling for maximum 10 seconds (the temperature of the cylinder should not be higher than 65 °C/ 149 °F)!!! Otherwise it could result in permanent damage to the engine and exhaust system.

IMMEDIATELY AFTER RIDING:

- 1) Pull the JetSurf™ onto the shore, put it on the ground with the nose up and wait until the rest of the water from inside of the board drains out.
- 2) Start the engine in the nose up position, rev twice and let it run for 3 to 4 seconds (this will remove water from the exhaust system; the engine can run without cooling maximum for 10 seconds, the temperature of the cylinder should not be higher than 65 °C/ 149 °F)!!! Otherwise it could result in permanent damage to the engine and exhaust system.
- 3) Wash JetSurf with freshwater including the inner space and engine and then let the engine run for about 5 seconds. Let the inner space dry out and spray the whole engine thoroughly with oil – e.g. MOTOREX INTACT MX 50 or other oil not damaging plastic.
- 4) Charge the batteries in the ICU.
- 5) Do not store the JetSurf™ with the engine bay closed.

MSR 0518/D1-EN

WARNING Support: info@jetsurf.com

 Always use a lifejacket type II or Coast Guard approved life vest	 The use of helmet is compulsory at all times.	 Do not use open flames near JetSurf™. Avoid spilling gasoline. Wipe off any spilled gasoline immediately. Do not start the engine if there is fuel inside the engine area or if there is a loose electrical connection.	 Before each ride, charge the battery (only with a charger provided by JetSurf™).	 Collisions result in most of INJURIES and DEATHS from all the accidents that can occur while riding JetSurf. INSPECT YOUR SURROUNDINGS CONSTANTLY for people, watercrafts and other objects that can limit your visibility or block your visibility for others. BE CAREFUL, ride at safe speeds, maintain your distance from people, watercrafts and other objects near you. Do not ride directly behind other watercrafts or boats. Do not attempt to spray or splash others with water. Avoid sharp turns or other unexpected maneuvers that make it hard for others to understand where you are heading. Avoid areas where you don't know if there are any submerged objects or you don't know how shallow the water is.
WEAR PROTECTIVE CLOTHING. Serious internal injuries can occur if water is forced into body cavities as a result of being near the jet thrust nozzle. Casual swimwear does not protect against forceful water entry to rectum or vagina sufficiently. All riders must wear at least a wet suit bottom or any other clothing that provides same protection (See Owner's Manual for more information). Footwear, gloves and goggles are recommended.	Caution! High voltage on spark plug, never remove the cap from the spark plug when the ignition is on (signaling LED should be off). Do not remove the cap from the spark plug with water inside board.	REMEMBER, JETSURF AND OTHER BOATS DO NOT HAVE BRAKES. DO NOT RELEASE THROTTLE WHEN TRYING TO STEER away from objects – you need speed to steer. Always check functionality of throttle before starting JetSurf. Follow navigation rules, state/province laws and any local laws that apply to watercrafts. See Owner's Manual for more information.		
Surfboard leashes must be worn at all times.	RIDE WITHIN YOUR LIMITS AND AVOID SHARP TURNS AND JUMPING WAVES OR WAKES to reduce the risk of loss of control, ejection or collision. Sharp turns and jumping waves or wakes increase the risk of spinal injury (can lead to paralysis), facial and head injuries (concussion) and broken legs, ankles and other bones. JetSurf is not a toy. DO NOT PRESS THROTTLE WHEN SOMEBODY IS STANDING AT REAR OF JETSURF – keep engine turned off completely. Water and debris exiting propellers can cause serious injury. KEEP AWAY FROM TURBINE'S WATER CANAL while engine is running. Long hair, loose clothing or loose straps from a life vest can become entangled in the propellers resulting in serious injury or drowning. When you fall from JetSurf, try to start engine and jump back on as fast as possible, but make sure that you are not at rear when engine starts.	 Read the manual!		

DO NOT TRANSPORT JetSurf™ WITH THE TANK INSIDE!

MSR 0718/D2-EN

2A SAFETY MATTERS

BEFORE USING THE POWER BOARD THE FIRST TIME, READ THIS ENTIRE OWNER'S MANUAL.

If any of the information is not clearly understood, contact the Authorized Dealers for clarification and further understanding prior to operating the power board. Safety is the primary concern of Jet-Surf™, and it needs to be for all owners and operators as well.

The Safety information provided in this Owner's Manual cannot anticipate every circumstance that may arise while maintaining and operating the power board. Basic safety information is provided and it is not all-inclusive. JetSurf™ strongly encourages all owners and operators to regularly review the U.S. Coast Guard safety information (www.uscg.mil and www.uscgboating.org)* and other safety-minded, watercraft websites and authorities which apply to the relevant area/region under which the JetSurf™ power board is to be operated.

This is the safety alert symbol. It is used to alert you to potential personal injury hazards. Obey all safety messages that follow the symbol to avoid possible injury or death.



DANGER indicates an imminently hazardous situation which, if not avoided, will result in death or serious injury.



WARNING indicates a potentially hazardous situation which, if not avoided, could result in death or serious injury.



CAUTION indicates a potentially hazardous situation which, if not avoided, may result in minor or moderate injury.



NOTICE is used to address practices not related to physical injury. This information could result in damages to the product that are not covered under warranty.

These precaution icons will appear throughout the Owner's Manual.

* Valid for the USA

SAFETY MATTERS

DEFINITION

“Power board” or “motorized surfboard,” interchangeable terms in this Owner’s Manual, mean a vessel that uses an inboard petrol-and-oil-powered engine, providing power to a water-jet pump as its primary source of propulsion power. It is designed to be operated by a person (“rider” or “operator”) sitting, standing or kneeling on the vessel. Direction of JetSurf™ is controlled by rider leaning to one side or another, speed is controlled by throttle trigger located on the handle.

GENERAL COMMON SENSE



It is the responsibility of the owner and/or operator to comply with safety-related material provided in this Owner’s Manual and to regularly review safety information provided by governmental agencies and local jurisdictions. Common sense should guide owners/operators at all times, regardless of whether the engine is running or not. Failure to do so will result in serious injury or death.

Riders are reminded that general common sense should be the rule for any and all outings. While some objects appear above water and are easily avoidable, it may be necessary to pay special attention to underwater objects as well.

In using the power board, some common sense considerations are for safety of the rider and other vessel riders, boaters and passengers, while common sense also is necessary to preserve the power board in good shape.

JetSurf™ cannot anticipate every type of activity or negligent performance that could result in death/injury or damage. The operator accepts responsibility for use of the power board in a safe and sensible manner. Particular attention must be paid to surroundings at all times to avoid accidents. Care must also be taken to avoid situations in which carbon monoxide fumes may become trapped between objects or may be released out-of-the-water. Be certain to read the information regarding carbon monoxide poisoning contained in this section of the Owner’s Manual.

With regard to damage to the power board, riders should avoid running it all the way to shore. Often, beaches or shoreline are made up of rocks and/or sand that can scratch or dent the power board. Such occurrences are not covered under the JetSurf™ Limited Warranty statement, which appears later in this Owner’s Manual.

Familiarity with the nautical waters in which the power board will be operated is extremely important. Currents, especially strong ones, can affect the performance of the power board and threaten the safety of the operator. Pay attention to buoys and other markers also.

It is critical for all owners and operators to be prepared to maintain and operate the power board in a responsible and common sense manner at all times.

All riders must use helmet, life vest and a safety leash at all times while operating JetSurf™ to prevent any serious injury or death in the events of accident (you can find more details in CLOTHING category).

SAFETY MATTERS

CARBON MONOXIDE



Carbon monoxide (CO) is a gas and it can be extremely difficult to detect, because it has no color, taste or odor and it can accumulate without awareness. Exposure can be fatal in a matter of minutes. The effects of CO are cumulative and repeated exposure to low amounts can have a similar effect to a single high concentration exposure. Carbon monoxide should be avoided, while any exposure should be treated immediately.

The exhaust on the power board is purposely located at the stern (rear) of the board. While emissions from the engine are relatively low due to its purpose-built design which ventilates into the water under normal operation, there are still some CO fumes as a natural by-product of a combustion engine. Therefore, riders must operate the power board as designed. No one should ever be towed behind the power board while it is in operation. The engine should not be operated when the power board is out of the water (this can cause damage to the engine from over-heating also).

CO enters through the lungs and blocks oxygen. Milder symptoms of poisoning include headache, nausea, itching or irritated eyes and dizziness. Victims often become increasingly weak and disoriented. These symptoms should not be confused with alcohol intoxication.

Individuals who suffer from lung- or heart-related issues may be affected more quickly. Alcohol and tobacco use also accelerate symptoms. For all riders, regardless of health or ingestion, note that physical activity will also hasten CO absorption.

In the even that someone shows evidence of CO poisoning, immediately shut off motorized surfboard or any other combustion-engine in the area. Provide fresh air, if possible, and move the victim to an area away from the CO concentration. Provide first aid and seek professional medical assistance immediately.

ENGINE PREPARATION



Operation of the power board engine out of the water for more than ten (10) seconds can result in permanent damage to the engine and exhaust system, (temperatures of cylinder shouldn't be higher than 65 °C/ 149 °F). Such damage is not covered under the warranty.

Touching any part of a running engine, in particular any component that is moving, can result in serious injury or death. If it is necessary to access or touch an engine for any reason, the engine must be turned off. Engine also become increasingly hot with usage and can result in skin burns if engine is not allowed to cool prior to touching it.



Never transport fuel except in D.O.T. (USA) or CE (Europe) -approved containers.



Transporting fuel in the engine or fuel tank can result in damage to JetSurf™ or injury to people handling the board. Fumes from fuel are even more volatile, explosive and generally dangerous than liquid fuel. Never transport JetSurf™ power board with the tank inside. JetSurf™ transport is described in detail in the chapter "TRANSPORT" page 41, part A.

Later in this Owner's Manual are instructions for the proper preparation and maintenance of the power board's engine. Be sure to read and follow these instructions.

Note also that operators should regularly verify that the engine is properly installed and firmly affixed to the engine housing. **DO NOT** attempt to start an engine that is not secure!

Operators and bystanders should **NEVER** touch any part of a running engine.

Avoid allowing any object, even small bio-degradable items (seaweed, sand, small animals...) to come into contact with the engine. This could result in damage to the engine that would not be covered under warranty.

Use only JetSurf™-approved (manufacturer) replacement parts. Using any other parts will void the warranty and may adversely affect the operation and safety of the power board.

When starting the engine, ensure that individuals (especially children) are at least 33 feet/10 meters away.

The engine was designed and crafted for the JetSurf™ retail power board only. Never use the engine for any other craft, object, projectile, or item. Such usage is expressly prohibited.

CLOTHING



Persons in range of the power board's engine moving parts should exercise caution to avoid having clothing or hair come in contact. If clothing or hair become entangled in moving parts, injury may result.

Because the engine has moving parts, owners/operators should never wear loose clothing when the engine is in operation. Straps, buckles, as well as the edges of cloth can become entangled in JetSurf™ moving parts.

If the owner/operator has long hair, it should be tied up or secured in some fashion so that the hair cannot become entangled in the engine's moving JetSurf™.

An injury can occur nearby the jets as a result of water influx into the body cavities. Conventional swimwear does not protect sufficiently against water being forced into rectum or vagina. All the riders must wear at least the bottom part of the neoprene suit or any other garment providing the same protection. We recommend wearing footwear, gloves and glasses.

Helmets are a compulsory item of safety gear and must be worn at all times while riding. It is expected that operators will, from time to time, fall off the power board, even in normal operation. Helmets provide protection in the event the operator's head would strike the board. Helmets are therefore a mandatory accessory and should be manufactured to wear on the water, fit properly and be relatively lightweight. Manufacturer JetSurf™ makes no claims nor promises regarding protection, including that afforded by helmets.

The use of an arm or leg leash is compulsory and must be used at all times while using JetSurf™.

PERSONAL FLOTATION DEVICES (PFDs)

It is the responsibility of the owner/operator to comply with any and all laws, statutes and requirements for personal safety. American federal law requires the wearing of a U.S. Coast Guard-approved* personal flotation device (PFD) under most circumstances. State and local laws and statutes may also vary from federal requirements.

As JetSurf™ power boards are commonly defined as personal water craft it is essential for all users to check with their relevant local Authorities for all information relating to the use of safety accessories. JetSurf™ takes no responsibility for failure of users to comply with the relevant laws which apply to the use of personal water craft in any specific location.

Authorized dealers are able to assist owners and operators in ensuring that they are properly outfitted for conditions and to comply with the law of the countries where JetSurf™ is used.

* Valid for the USA

SAFETY MATTERS

LAW ENFORCEMENT

When underway, operators may be required to cease manoeuvres and allow U.S. Coast Guard* or state law enforcement personnel to come alongside. Some Countries, States and jurisdictions may require a minimum age to operate the power board, pass a training course, and/or possess an operator's license. Requirements vary widely. If operating in a location that allows minors, such activity should be done only under adult supervision.

Be sure to check annually regarding requirements for legal and safe operation of the power board.

UNDER THE INFLUENCE

Under no circumstances should a power board rider ever operate under the influence of alcohol or drugs, including prescription drugs that have potentially disorienting side effects. This can be as dangerous as driving a car while under the influence!

REGISTRATION

In many jurisdictions, it will not be necessary to register the power board with the state of principal use. However, because the power board is motorized, registration may be necessary. Verify with the state and local law enforcement entities in the area in which the power board will be used most prior to using for the first time.

SPEEDING/NOISE

Some areas have restrictions regarding speed related to creating waves and maximal noise restrictions. Operators of power boards are required to adhere to these requirements.

ELECTRONIC DEVICES

Operating the power board requires full attention. JetSurf™ strongly recommends leaving cell phones (including waterproof models), radios, iPods, and other devices ashore during outings. The distractions can potentially lead to accidents.

JUMPS ON JETSURF™

NEVER JUMP with the motorized power board! Damage caused due to incorrect use of your JetSurf™ (for example jumps) is not covered by the guarantee.

* Valid for the USA

SAFETY MATTERS

REPORTING ACCIDENTS AND INSURANCE

Federal law requires reporting of accidents in which:

- A person dies;
- A person disappears from the vessel in what appears to be a situation that could have resulted in death or serious injury;
- A person is injured and requires medical assistance beyond minor first aid;
- Damage to vessel and/or property that exceeds the amount stipulated by law. The total may be lower in some jurisdictions and it is the responsibility of the owner/operator to verify;
- The power board is destroyed.

Any instance in which other vessels or persons appear in distress, power board operators are required by law to offer assistance unless doing so would result in potential danger to the power board operator. Good Samaritan protection is provided to anyone who offers good faith assistance.

Even when others operate the power board, the owner is generally responsible for damages or injuries that may occur. Owners must not allow any Third Party to operate the JetSurf™ without prior instruction in correct use and operational risks. Owners are strongly encouraged to carry sufficient liability and property insurance to provide in anticipation of potential judgments in those instances. Theft and on-shore damage are additional reasons to purchase insurance.

REFUSE AND POLLUTION

The U.S. Coast Guard* and/or relevant Authority which applies to the region where the JetSurf™ is used provides detailed information regarding the disposal or refuse. In general, refuse, even bio-degradable, should be disposed properly on-shore. If the user deduces that there are any substances that could pollute waters leaking from the board, it should be presented to an authorised JetSurf™ dealer for repair. Pollution laws and regulations are stringent in most areas.

At no time should the power board owner and/or operator alter the engine exhaust system or fuel system in any fashion. Doing so is both illegal and potentially dangerous.

* Valid for the USA

SAFETY MATTERS

OTHER SAFETY MATTERS



Riders should:

- Be at least sixteen (16) years old or the minimum age required within the jurisdiction in which the power board is operated. The power board was designed to be operated by adults.
- Wear appropriate safety gear especially a Helmet and Life Vest and safety leash.
- Ensure the power board is in excellent condition and ready to operate in top form. Have sufficient fuel for the outing or gear the outing to the generally expected period of time that fuel will remain, and be sure that the ignition battery is functional and well-charged to avoid becoming stranded away from shore.
- Avoid operation during bad weather, including but not limited to, high winds, rain that obscures vision, warnings of impending threatening weather, high waves, or any weather in which the rider feels at all uncomfortable.
- Do not use the power board, if the air temperature is lower than 2°C.
- Avoid operation in water that is too shallow or is brackish. Because the power board engine is water-jet pump propelled, weeds and other flora can foul the engine intake. If it is suspected that fouling agents or small objects have been brought into the pump/engine system (height of water stream coming out of engine cooling system nozzle output will get smaller or end completely), immediately cease operation and perform a typical maintenance operation to clean the system.
- Maintain a speed and operational method that ensures the rider can avoid collisions with objects (above and below the waterline), buoys, docks, shorelines and other vessels.
- Know and practice navigational rules and regulations.
- Maintain an unobstructed view at all times, particularly in the direction the power board is moving.
- Ride singularly on the power board. Multiple people on one power board can overload it and cause it to sink. The power board is built with anticipation of one (1) average-sized person per board.
- Never exceed the highest loading capacity.
- In addition, it is necessary for the rider to maintain line-of-sight, which means there should never be another person in front of the rider as the outing progresses.
- Not carry aboard any item. The power board requires the rider to maintain control via the control handle. The rider should never be distracted from control of the power board.
- Always keep the engine shut-off key with kill switch Paracord around the wrist so that when the rider goes overboard the engine will be immediately shut down.

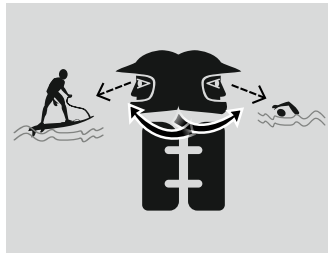

SAFETY MATTERS

SAFE OPERATION ON THE WATER

Laws, rules, regulations and enforcement have been developed in North America and around the world to ensure safe and proper operation of all watercraft. It is the responsibility of the owner and/or operator to familiarize himself or herself with all applicable ordinances on the body of water upon which the JetSurf™ power board will be operated. For operators in the United States, refer to the website*: www.uscg.boating.org

In Canada, refer to the website**: www.tc.gc.ca/eng/marinesafety/menu.htm

Other countries have their own laws or participate in international rules. Always verify markings and rules as they apply to any body of water on which operations will be conducted.

GENERAL PRUDENTIAL RULE

Rule 2 in the International Rules says, **“In obeying and construing these rules due regard shall be had to all dangers of navigation and collision, and to any special circumstances, which may render a departure from the above rules necessary in order to avoid immediate danger.”**

GENERAL EXPECTATIONS

Always use common sense when encountering other vessels. The power board is considered a powered watercraft and will be expected to give-way to non-powered vessels that have less maneuverability. The vessel that does not has the duty to take proper and timely action to stay out of the way of the stand-on vessel. Normally, the give-way vessel should not cross in front of the stand-on vessel. Always move in such a way that the stand-on operator can see the operation.

When encountering other powered vessels, there are three (3) main situations that could require avoiding a collision:

- Meeting (approaching another vessel head on);
- Crossing (travelling across the other vessel's path);
- Overtaking (passing or being passed by another vessel).

When meeting another vessel head on with the risk of collision, neither has right of way. Both vessels must alter course to avoid an accident. Keep the other vessel on the port (left) side unless it is possible to clear each other by maintaining course.

When two (2) power-driven vessels cross paths with risk of collision, the vessel that views the crossing vessel to the starboard (right) side must give way.

When overtaking, you are the give-way vessel. The other vessel is expected to maintain course and speed. Avoid it as you clear it. When being passed by another vessel, maintain speed and direction so that the passing vessel can clear.

In other circumstances, when preparing to go around a bend on a body of water, sound a prolonged blast on a whistle for four (4) to six (6) seconds. Regardless of whether you hear a response, proceed with caution.

* It applies to the USA; ** It applies to Canada

SAFETY MATTERS

Under normal operation situations, stationary fishing and sailing boats (stationary or moving) are given the right of way.

Always learn about and pay attention to buoys and other markers. The Uniform State Waterway Marker System has been devised for interior waterways in the United States*. Markings may vary by geographic location. Always consult appropriate authorities before using the power board in unfamiliar waters.

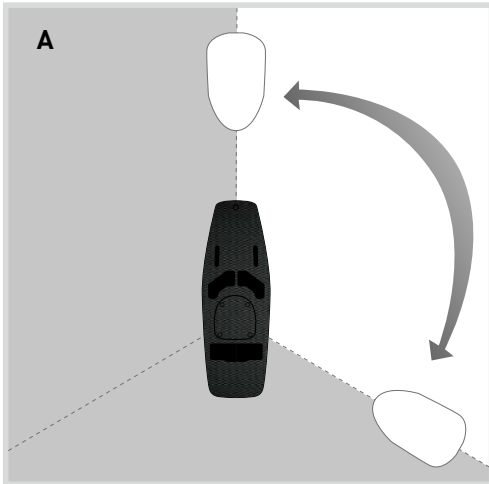

MEETING

When two boats are approaching each other on the water, one has the right-of-way and is designated the "stand-on" vessel. The other boat must yield or give way and is designated the "give-way" vessel. In illustration A, you are the JetSurf™ in the center. You are required to yield to any vessel shown in the white area (you are the "give-way" vessel). Any vessels shown in the shaded area must yield to you (you are the "stand-on" vessel). If both of you are heading directly toward one another, illustration B, you both must give way. You should turn right to keep the approaching vessel to your left or port side. This rule does not apply if both vessels will be clear of each other if you continue on your set course and speed.

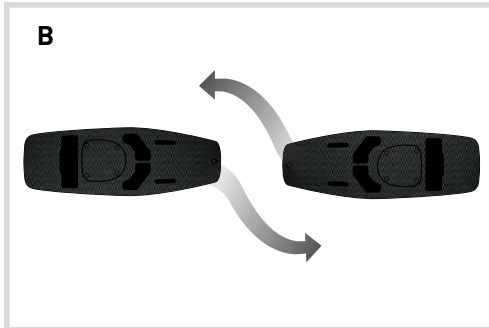

SAFETY MATTERS

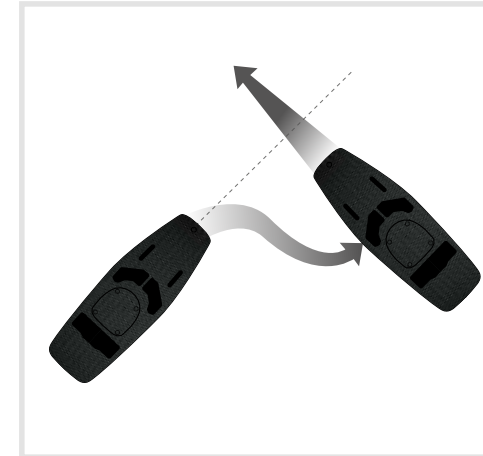

CROSSING

If you and another vessel are crossing paths close enough to risk a collision and the other vessel is on your right (starboard) side, you must yield or stay out of its way. If the other vessel is on your left (port) side, you must maintain your course and speed, as long as the other vessel yields the right-of-way to you, as it is required.

OVERTAKING

If you are passing another vessel, you are the "give-way" vessel.

The other vessel is expected to maintain its course and speed and you are required to stay out of its way until you are clear of it. If another vessel is passing you, you should maintain your course and speed so that the overtaking vessel can steer safely around you.

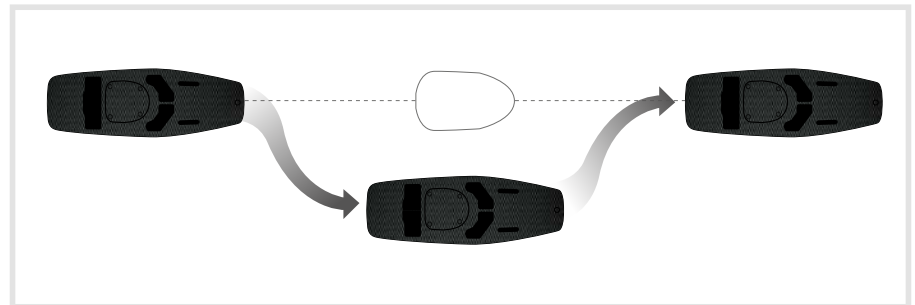

JetSurf™ cannot anticipate every circumstance that can occur in operating the power board. The information provided is general in nature and may not apply to the location in which you will be operating the power board. Always perform due diligence in preparation and planning for all outings, with particular attention to doing so in the safest manner possible.

3A RIDE

BEFORE YOU START

Before your first ride without being supervised by a Authorized Dealer or a coach of JetSurf, please make sure that you have read and understood the manual supplied together with the power board.

Familiarize yourself with the laws valid for the water bodies where you intend to use your motorised power board.

STAND AND ITS UNFOLDING

Every JetSurf™ is supplied with a light stand. The stand should be used on a solid levelled surface and it is only used to keep the JetSurf motorized power board in a comfortable height. Use of the JetSurf stand is strongly recommended to keep the JetSurf motorised power board above the ground, it is intended as an aid for preparation, maintenance and cleaning of the motorized power board.

STAND ERECTION

Place all four rods parallel - FIGURE 1. Take the ends of the rods which are farther from the stand clip and turn them gently clockwise - FIGURE 2. Then take the opposite ends of two rods (the side where the ends of the rods are closer to the stand clip) and pull these ends apart - FIGURE 3.

Make sure that the stand is situated on the solid surface and that the power boards rests on the stand correctly (the engine should be directly above the stand and all four rods of the stand touch the power board).

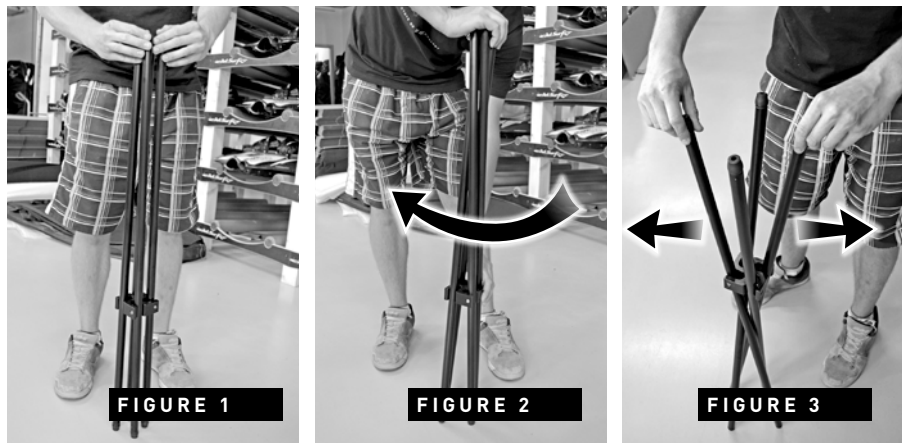

FINS

FASTENING OF SIDE (SMALL) FINS

First unscrew the long screw which is screwed in the fin. Slide the side fin into the opening in the bottom side of the board. Make sure that the fins are oriented correctly - FIGURE 1. Find the opening in the top side of the power board (it is situated nearby the straps, above the fin). Insert the long screw you have screwed out of the side fin into the opening - FIGURE 2. Fasten the fin

using a cross-head screwdriver PH 2x100 (supplied with the tools). **TIGHTEN GENTLY.** Please check whether the fin is tightened up, the fin should not move. Fasten the other fin in the same way.

MAIN FIN FASTENING

Unscrew 4 M 6x8 Allen screws from the platform - FIGURE 3. Place the main fin on the platform. Make sure the fin is oriented correctly. Insert the removed screws in the openings on the main fin and fasten the fin - FIGURE 4. Check for tightness - the fin should allow any movement.

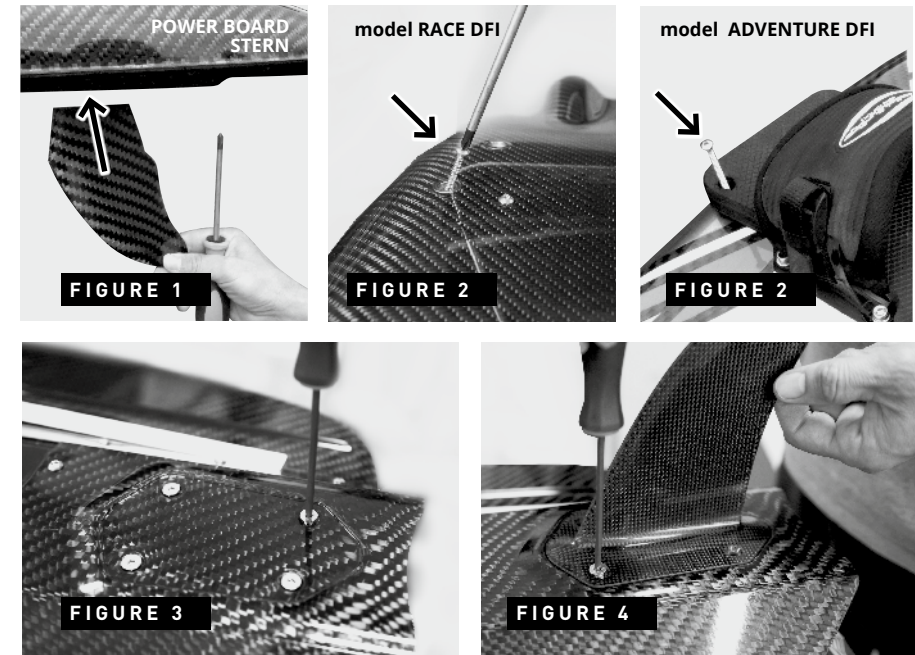

NOTICE

Keep all the screws openings for attaching fins clean, without sand and other impurities which might damage the thread. After several rides, lubricate the screw openings with Vaseline to prevent their corrosion.



CAUTION

It is strongly recommended to use all fins under all circumstances. It ensures the maximum control of the movement of the motorized power board.

We strongly recommend removing all fins when transporting the JetSurf™ motorized power board. The fins are delicate and are not designed to support the power board weight on hard surface. Transporting the power board with the fins attached may result in damage to the fins and/or power board.

RIDE



NEVER leave the side fins screws loose in the board during transporting the JetSurf™, always pull them out. Similarly we recommend screwing the main fin screws into the base even without the fin.

STRAPS

JetSurf™ have fully adjustable straps. They can be adjusted by pulling the loose ends of straps with force or by means of plastic buckles. Make sure that the straps are comfortable and are not too loose or tight.

HOSES

Check all the connections. Check also all the hoses whether they are not worn or cracked. Check for cuts, scratches, cracks and bulges. Make sure that the hoses are not kinked or squeezed and that there is no fuel leak.

CHECK ALL OF THE FOLLOWING:

Fuel hoses

Transparent hose of exhaust cooling

Blue cooling hoses

Drain hoses

If a tube is damaged in any way, replace it immediately and check all the other tubes whether they are not damaged.

Make sure that all the tubes are laid correctly and fastened with clamps at a sufficient distance from the moving parts and parts with sharp edges.

ELECTRIC CONNECTIONS

Before the ride check ALL the electric connections carefully. Pay special attention to the spark plug boot (to prevent it coming loose during the ride), correct placement of the feeding cable from the ICU and proper fastening of all the connections. Also make sure that the cover of charging cable is properly connected when the board is not being charged.

Before every ride, remove the spark plug and check it. Generally, for proper operation of the power board, Jetsurf recommends changing the spark plug every 6 hours of the ride.

Check whether all the connections are fastened properly by pulling both ends slightly away from each other. If you are not sure, we recommend disconnecting and reconnecting. The connectors are equipped with a clip which must be pushed when being disconnected (preferably with thumb) until it "clicks". After the clip is released, you can disconnect the connector. To reconnect the connectors, simply push both ends together until you can hear a click.

CONTROL HANDLE

Check the throttle trigger allowance. If the allowance is incorrect, adjust the throttle cable. Check several times whether the throttle trigger moves smoothly from the fully open position to the fully closed position and that it closes quickly and completely by means of a return spring.

If the throttle trigger does not return correctly, check the throttle cable line, cable adjustment and cable damage.

RIDE

CHARGING OF THE ICU BATTERY

Before the ride make sure that the battery is fully charged.



When battery are being charged, tiny electric charges and potentially also sparks may be generated. Never charge the battery when there is petrol or its vapours present as an electric discharge could cause an explosion, which may result in serious injury or death.

The battery power the electronic system of the motorized power board. Correct handling of battery, mainly when they are being charged up, plays a crucial role for their safe use. Follow the provided instructions concerning the use of the battery and handling them. The failure to observe these instructions may result in serious injury or death.

The control unit (ICU), starter and the electric bilge pump are powered from Li-Ion batteries situated inside the control unit (ICU). In order to protect all the persons in the surroundings as well as the user who is charging the battery, please pay attention to these important steps:



- NEVER charge the battery when the engine is in operation.
- NEVER charge the battery when the ignition control unit (ICU) is ON and the indicator is flashing.
- NEVER charge the battery when the engine of the motorized power board is in water.
- ALWAYS wipe the charger connector dry and prevent any water from getting into the charger connector.
- NEVER use the charger if the power cable is damaged mechanically or oxidised.
- NEVER use a different charger other than the one specified by JetSurf™.
- ALWAYS put the dry charging connector cover back after charging.
- When charging, do not leave the charger unattended and do not expose it to direct sun or at least cover it so that it could cool down
- Follow the manual supplied with the charger.

HOW TO CHARGE BATTERY USING A CHARGER

The charger is supplied in a protective cover. When charging, you do not have to take the charger out of the cover, it is adapted to charging.

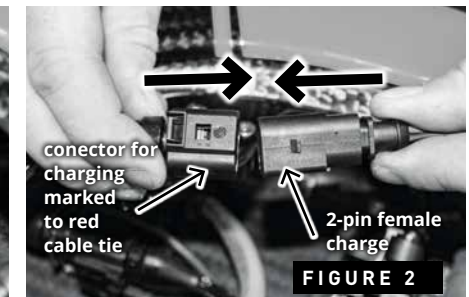
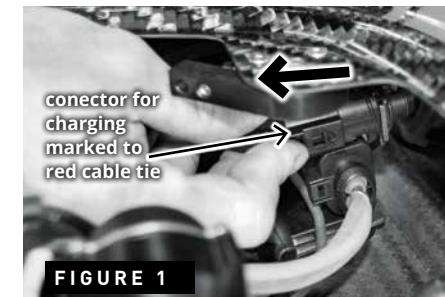

1) Disconnect the 2-pin connector (marked with a red cable tie) which is connected in the connector holder – FIGURE 1.

2) Connect the charger to a 12 V socket in the car or to a 110/220 V power cable.

Never charge the battery while the car is moving as there is a danger of damage to both the charger and the ignition control unit (ICU).

3) Connect the charger to the charging connector on the control unit (ICU) – FIGURE 2. **Never disconnect the charger when charging from the ICU!!!**

4) When the charger is connected to the ICU, charging options will be displayed on the touch screen – FIGURE 3. The default setting by the JetSurf manufacturer is charging of Li-Po battery which are charged in the same way as Li-Ion battery in the ICU.

Select one of the charging modes on the display (the parameters of the individual modes are preset by the manufacturer).

MODE2: CHARGE – it is intended for charging between the individual rides. Check the default parameters preset by the manufacturer displayed on the screen – FIGURE 4 a.

MODE3: STORAGE – it is intended for charging for storage. Check the default parameters preset by the manufacturer displayed on the screen – FIGURE 4 b.

5) When a mode has been selected, press the green button START. The charger will beep and the battery charging will start. The charging progress is displayed on the screen – FIGURE 5.

If the battery is not connected or it is connected incorrectly or if there is any other problem, an error message “CONNECTION BREAK” will be displayed on the screen and the charger will start beeping. Press START when asked to do so.

7) When the battery is fully charged up, the display will read Li-Po END and the charger will beep twice.

8) The STOP button will finish the charging process.

9) Disconnect the charging connector from the charger and put the connector cover on back the connector holder.

10) Disconnect the charger from the source.

Fully charge battery last approximately two (2) to four (4) rides depending on the style of riding.

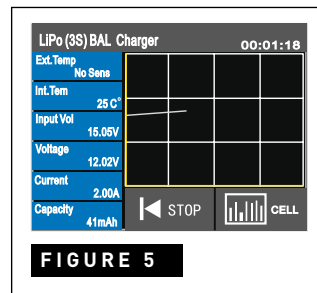
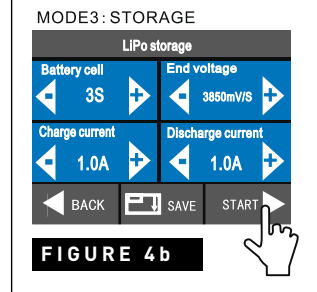
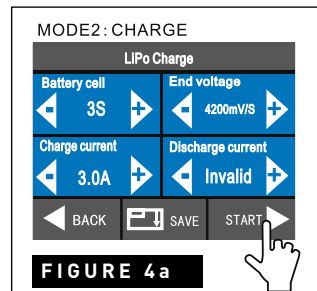
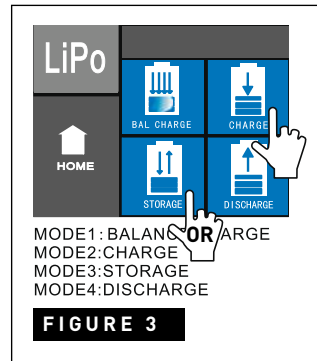

Note: We recommend charging battery continuously (for example when you have a break between the individual rides). Repeated short charging cycles do not affect the battery life. **However, in the first 5 cycles it is absolutely necessary to charge the battery to its full capacity and avoid rapid discharging to the minimum level.**



AFTER HAVING CHARGED THE BATTERY, NEVER FORGET TO INSERT THE ICU CONNECTOR IN THE CONNECTOR HOLDER. ALWAYS CHARGE THE BATTERY BEFORE AND AFTER THE RIDE. AFTER THE RIDE, DO NOT LEAVE THE BATTERY FLAT. CHARGE THEM TO MINIMUM 50 % OF THE CAPACITY. IN WINTER OR WHEN NOT USING JETSURF, IT IS NECESSARY TO CHARGE THE BATTERY IN THE ICU MINIMUM ONCE IN EVERY 3 MONTHS.

USED MODES OF BATTERY CHARGING

MODE2: CHARGE	Mode intended for charging between the individual	
MODE3: STORAGE	Mode intended for charging the JetSurf™ for storage	



FUEL TOP-UP

DANGER

Observe all the safety instructions specified in this manual, mainly the chapter FUEL TANK (part B).

NEVER add fuel into the tank which is inside the JetSurf™. **Before adding fuel, ALWAYS** take the tank out.

FUEL TANK REMOVAL

1) Disconnect the second CPC coupling connecting the tube coming out of the tank to the tube going to the injector – FIGURE 1. The CPC coupling has a security clip which must be pressed when disconnected.

2) Disconnect the fuel pump connector – FIGURE 2.

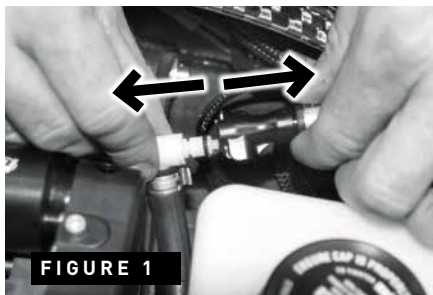

FIGURE 1

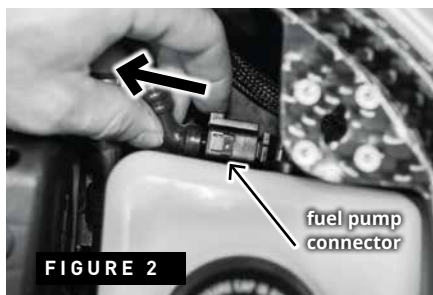

FIGURE 2

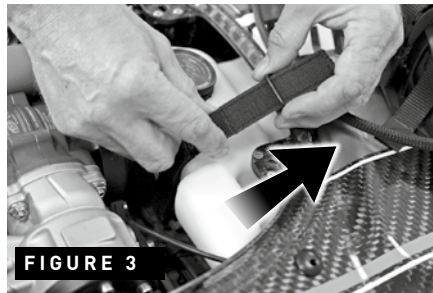

FIGURE 3

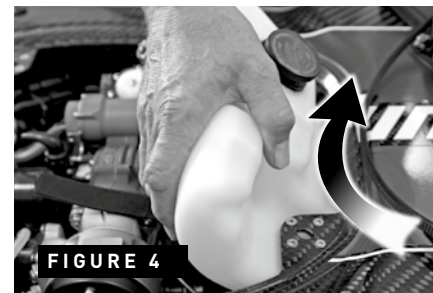

FIGURE 4

3) Undo the velcro on the tank – FIGURE 3.

4) Move the tank out upwards – FIGURE 4.

5) Disconnect the hose on the other side of the tank – FIGURE 5 leading to the suction hose.

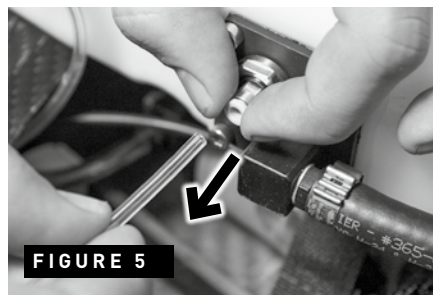

FIGURE 5

FUEL MIXING

JetSurf™ uses mixture of gasoline (natural 95 octane) and oil (full synthetic).

Every time use only petrol mixing bottle container approved for gasoline mixing. This petrol mixing bottle container must be approved - D.O.T (USA) or CE (Europe).

Use lead-free car petrol with the octane number 95 or higher mixed in the proportion of fifty (50) parts of fuel to one (1) part of MOTOREX OCEAN FS 2T BIO; or oil meeting these standards: NMMA TC-W3, API TC, ISO-L-EGD: JASO FD/FC; TSI.

PETROL TO OIL MIXTURE		Example:
50 : 1		To 1 litre of petrol add 0.02 l (20 ml) of oil
		To 2 litres of petrol add 0.04 l (40 ml) of oil

**CAUTION**

Make sure that petrol and oil are mixed properly in the correct proportion. If the proportion is not observed, the engine may get damaged.

Before every ride, make sure that the fuel tank is fastened well using a velcro. A slight sideways movement after applying force is normal but it **MUST NOT COME INTO CONTACT WITH ANY PART OF THE ENGINE DURING THE OPERATION**. Pay special attention to the safe distance between the gear cover and the fuel tank and make sure they cannot come into contact.

LUBRICATION

Before the ride it is recommended to lubricate the engine with a conservation spray, e.g. MOTOREX INTACT MX 50, mainly before riding in salt water. **Sea water causes corrosion of metal parts of the engine and if you spray these parts with a preservation spray, you will decrease the corrosive effects of salt water.**

When lubricating, pay special attention to the moving parts, shaft bearing – FIGURE 1 and such as gears (they are under the carbon cover) – FIGURE 2. Apply the grease in the exhaust silencer – FIGURE 3 on the next page.

Generally, spray the whole engine.

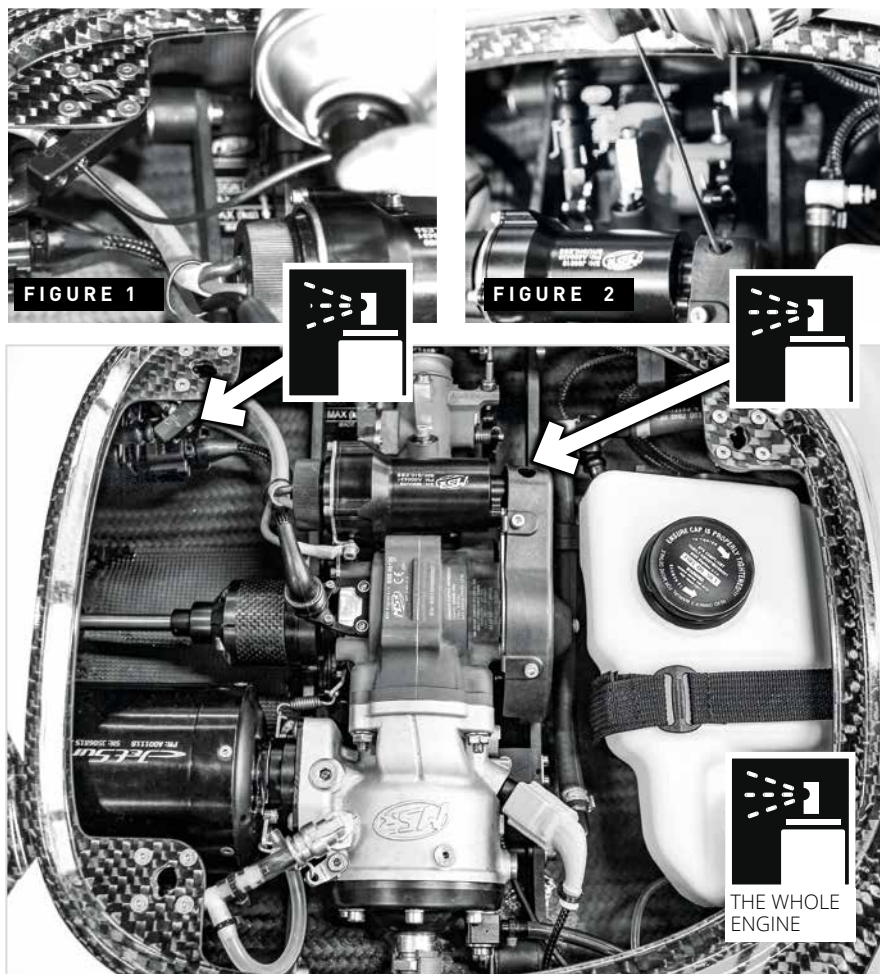

FIGURE 3

START AND FIRST RIDE

SWITCHING ON THE IGNITION CONTROL UNIT (ICU) AND STARTING THE ENGINE



NEVER start the engine in an enclosed area, such as a garage. In such places, carbon monoxide (CO) fumes may be trapped, which can result in death or serious injury, as described in the section Safety of this user manual.



Before switching on the ignition control unit (ICU) and starting the engine, make sure that the engine is **FASTENED** and that the screws holding the engine in the holders are **TIGHTENED** carefully. If the engine is fastened incorrectly, it can result in a serious damage to the engine and/or fuel tank as well as the motorized power board. Such damage may lead to a serious injury or death.



Keep your arms, legs and other body part away from all the jet inlets when the engine is in operation. It could result in a serious injury or death.



When starting the JetSurf™, make sure that people (especially children) are at least 10 meters/33feet away from water-jet pump.

Operation of the motorized power board engine outside water for longer than 10 seconds can result in permanent damage to the engine and exhaust system. Such damage is not covered by the guarantee.

DO NOT leave JetSurf™ in direct sunlight or anywhere that would allow its surface to rise to a temperature in excess of 65°C/149°F. Excessive temperatures can cause damage to the engine.

Be aware that the JetSurf™ motorized power boards are not intended or designed as swimming aids. Do not leave the motorized power board unattended or in water without the engine running for a longer time, there is a danger of its sinking.

Before starting, **ALWAYS** make sure that there is no petrol leaked anywhere in the engine compartment.

CONTROL HANDLE

It is **ABSOLUTELY NECESSARY** for the rider to release the control handle when he/she loses full control of the board or balance during the ride. Pulling the engine shut-off key from the engine shut-off switch will stop the engine immediately. **NOT PULLING THE ENGINE SHUT-OFF KEY FROM THE ENGINE SHUT-OFF SWITCH MAY RESULT IN SERIOUS INJURY OR DEATH.**

PROTECTIVE AIDS

It is necessary to use all the protective aids all the time. They include:

- Helmet
- Life jacket
- Safety leash on the leg or arm



If the JetSurf™ is ready (the chapter Before start), you can start using it. To check whether the engine is working and warmed-up, first try the device out of water – BEFORE EVERY RIDE.



The JetSurf™ is cooled with water and can run on land without the water cooling only for a limited period of time. Otherwise it can get damaged. Therefore do not leave it started longer than necessary. To warm up the engine, it is enough to let it run for 3-5 seconds on (and BUT NO LONGER THAN 10 SECONDS as it can cause overheating of exhaust system and it's destruction).

JETSURF™ STARTING

Note: the starting process has two stages. Read these instructions carefully in order to understand them completely.

STAGE ONE – ICU activation

1. Insert the engine shut-off key in the engine shut-off switch placed on the upper part of the control handle for minimum 4 seconds (BUT LONGEST FOR 30 SECONDS!!!), then take the key out. The ignition control unit (ICU) will switch on and also the other accessories (such as a bilge pump) will be activated. The control unit activation is optically signalled by the indicator lighting and activation of the electric bilge pump which you are able to hear (see the chapter Ignition control unit).

Note: The ICU will stay in this state for 5 minutes from the last time the engine shut-off key was pulled out of the engine shut-off switch. Then it will switch off automatically and in order to start the power board you will have to repeat this step.

WARNING: Start your Jetsurf without throttle (do not hold the throttle trigger on the handle).

STAGE TWO – engine start

2. Insert the key in the engine shut-off switch on the control handle a second time. In the ignition control unit (ICU), a three-second (3 s) delay has been programmed so that the rider could get into a safe position and hold tight the grips of the motorized power board before the engine starts. After this short delay, the engine starter will switch on and start the engine.

Note: The running engine can be switched off by pulling the key out of the engine shut-off switch.

WARNING: THE JetSurf™ STARTS REGARDLESS WHETHER THE THROTTLE IS PRESSED OR NOT. THE JetSurf™ THEREFORE STARTS EVEN IF THE USER DOES NOT HOLD THE THROTTLE TRIGGER ON THE HANDLE.

BRIEF DESCRIPTION OF STARTING

1. STAGE- ICU activation	
Inserting the engine shut-off key in the engine shut-off switch for 5 seconds	You can hear the electric pump
Pulling the shut-off key out	The ICU waits for 5 minutes for the key to be inserted for the second time
2. STAGE - start	
Inserting the engine shut-off key in the engine shut-off switch	After 3 seconds the engine starts independent of the throttle

During the time when the engine is running, check the engine operation both optically and acoustically. Check whether the engine acceleration is correct and whether the freewheel has been adjusted correctly.

WARNING! The correct engine operation is only checked on the engine when warmed up. After the very first start, the engine may run irregularly. In such a case repeat the start procedure once or twice.

The rider prepared to use the JetSurf™ MUST WEAR a life jacket, safety helmet and MUST HAVE the original JetSurf™ wrist band with the engine shut-off key attached to his/her wrist and it must be connected with the motorized power board by means of the safety leash.

For sharp start from water it is necessary to find a suitable place where to start riding. First it is necessary to have a sufficient depth from which we can start safely without damaging the bottom fins of the vessel. The minimum depth is 50 cm. Keep in mind that after starting the engine, the rear part of the board may sink by 10-20 cm.



Never start JetSurf™ in swimming areas. Also make sure that you have sufficient space for manoeuvring, mainly if you are a beginner. The ideal area is 300x300 m without obstacles and with smooth water surface. Always check water (the dirt and litter in the water) to avoid sucking them into engine or propeller and damaging JetSurf™.

STARTING FROM THE BANK (IN SHALLOW WATER)

In order to speed up the process of starting, we recommend performing of the engine check and warm-up (the first start stage) on the bank and carrying the started power board to water within 5 minutes where the second stage of starting will be performed.

The following picture – FIGURE 1 shows the correct position of the rider when starting from shallow water. The rider holds his/her JetSurf™ with both hands in such a way that with his/her more dextrous hand he/she is able to hold the vessel and control the throttle trigger at the same time – FIGURE 2. **The rider IS STANDING next to the board, NOT LYING on the board.** When the rider is in the correct position for starting, with his/her free hand in which he/she does not have control handle he/she can insert the engine shut-off key in the engine shut-off switch (on condition that the ICU has been activated) – FIGURE 3.

During the three-second delay between inserting the engine shut-off key and starting of the JetSurf™, the rider holds the throttle. After having started the JetSurf™ and its subsequent acceleration, the rider must jump onto the JetSurf™ with his/her full weight - FIGURE 4.

ATTENTION: For comfortable ride and correct functionality of the equipment it is necessary to hold the throttle for the whole ride. It is not necessary to keep the full speed but when the speed is not sufficient, the vessel becomes unstable and more difficult to control.



After the JetSurf™ gets going, check optically the correct cooling system operation. From the right side you should see a continuous flow of water coming out of the cooling system (at least 30 cm high). If you cannot see the water, stop immediately and check the vessel.



FIGURE 1

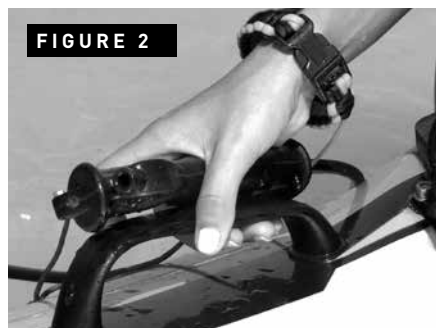

FIGURE 2



WRONG!!!



WRONG!!!



FIGURE 3



FIGURE 4

STARTING IN DEEP WATER OR AFTER FALLING DOWN

Starting in deep water happens similar to start from the bank. If after falling down the rider manages to insert the engine shut-off key in the engine shut-off switch within 5 minutes, the engine will start in 3 seconds (second stage of starting). **The rider does not get on the board until the engine is running.** After the engine starts, it is necessary to use the engine power and pull yourself back onto the JetSurf™ - FIGURE 5.

If it is not possible to start the JetSurf™ again after stopping on water, we **do not recommend repeating the starting procedure more than three times.** It is necessary to get the JetSurf™ on bank and check it there.

JETSURF™ CONTROL - THROTTLE

During the very first ride, the rider should learn how to operate the control handle and accelerate. **this skill is crucial for JetSurf™.** The rider can stay in the lying or kneeling position. Only when he/she knows how to control the throttle, he/she can stand up.

JETSURF™ CONTROL - TURNING

The next important step is turning. You turn the board by tilting the whole vessel to one or the other side.

JETSURF™ CONTROL - RIDING

The rider may be lying or kneeling. Only when he/she is sure how to control the throttle, he/she can stand up. Standing up is performed from the position kneeling on the engine cover.

If you want to stand up, make sure you have sufficient space for manoeuvring, you are not crossing the path of any other vessel and there is no swimmer or obstacle near your JetSurf. **When standing up, it is necessary to be riding fast enough** (the board is stable and riding without bigger resistance).

The way how to stand up from kneeling down is individual.

For beginners we recommend placing first one foot in the rear strap – left foot if you hold the control handle in your right hand or left foot if you hold the handle in your left hand.

If you have your foot firmly in the rear strap, place the other foot in the front strap – FIGURE 6.

When standing up, it is necessary to keep a constant speed, stand up gradually and not to stop halfway through.

If the rider falls down during getting up, repeat the whole procedure step by step. After every fall, JetSurf™ recommend continuing straight ride lying or kneeling for a while so that the bilge pumps can pump out the water which might have got into the engine compartment during the fall.

DANGER Always watch the time for which you are riding in water. With full tank, you can ride for 0.8 hours. Do not forget to have some reserve to be able to get back to the bank. When returning back to land, please keep in mind any potential swimmers near the bank and sufficient depth of water.



FIGURE 5



FIGURE 6

JETSURF™ CONTROL – STOPPING/FALLING

If the rider wants to stop, first he/she has to slow the JetSurf™ down before reaching the place of stopping. As soon as the rider is sufficiently close to the place of stopping, he/she will remove the key from the handle. JetSurf™ will slow down and the rider can leave the board.

DANGER

If you fall down, LET GO THE THROTTLE CONTROL HANDLE IMMEDIATELY!!!

It is NECESSARY TO PULL THE ENGINE SHUT-OFF KEY FROM THE HANDLE to stop the JetSurf™ safely.

DO NOT STAY ON THE JETSURF™ IN THE WATER IF THE ENGINE ISN'T RUNNING.

DON'T FORGET

AFTER EACH RIDE, PLEASE MAKE A HEARING CHECK OF THE ENGINE COOLING. IF JETSURF™ PRODUCES A DIFFERENT NOISE, PLEASE TRANSPORT IT TO THE LAND AND CHECK IT. THE ENGINE'S COOLING OUTPUT NOZZLE SHOULD PRODUCE A CONTINUOUS JET OF WATER OF AT LEAST 30 CM IN HEIGHT DURING THE RIDE.

AFTER THE RIDE

As soon as the rider pulls the power board from water, lean it against something with its tip up and wait for a while until most of the water has run out of the JetSurf™. Place the JetSurf™ on the stand and start it in the angle of 30 degrees with the jet pump facing down. Accelerate several times and switch off the engine. This way you will ensure that you will get the remaining water from exhaust and cooling system out of the board. **The engine operation time should not exceed 10 seconds!!!!**

To store the power board overnight, find a freshwater source (e.g. a garden hose) and **WASH THE INSIDE OF THE BOARD THOROUGHLY**. Then let the engine run for 5 more seconds (MAXIMUM for 10 seconds).

If the motorized power board was operated **IN SEA-WATER OR BRACKISH WATER**, place a garden hose to the engine cooling output and flush it out (water will start pouring from the jet pump). When dried out, spray the inside of the board with oil (MOTOREX INTACT MX 50) and make sure that the oil gets to the jet pump bearing, gears and all the moving parts.

IT IS ABSOLUTELY NECESSARY WASH THE JETSURF™!!!

Charge the ICU battery.

Leave the engine compartment lid open so that it could dry thoroughly.

**FIGURE 1****A BRIEF LIST OF TASKS TO BE DONE BEFORE THE RIDE**

Attach all the fins	page 22/part A
Set the straps	page 24/part A
Charge the battery in the ICU	page 25/part A
Top up the fuel	page 29/part A
Check the tubes of the cooling system and all the connections and tubes	page 24/part A
Check whether all the connectors are connected	page 24/part A
Check the spark plug boot, check the spark plug, check the spark plug boot holder (safety spring) so that boot can't get loose while riding	page 42/part A
Check the throttle control and fuel system	page 24/part A
Spray thoroughly all the engine parts with MOTOREX INTACT MX 50 oil	page 29/part A
Start the engine, check the engine operation and throttle control; MAXIMUM FOR 10 seconds!!! Otherwise the engine can overheat and destroy the exhaust system.	page 24/part A
Check the bilge pump	
Apply the grease in the exhaust silencer	page 29/part A

A BRIEF LIST OF THE TASKS TO BE DONE AFTER THE RIDE

Tilt the JetSurf™ and pour the water out of it	page 36/part A
Start the JetSurf™ with its tip up, MAXIMUM FOR 10 seconds!!!	page 36/part A
Wash the whole JetSurf™ with fresh water, including the engine compartment, then let the engine run for about 5 seconds (MAXIMUM FOR 10 seconds)	page 36/part A
Let the JetSurf™ dry	page 36/part A
Spray all the engine parts thoroughly with MOTOREX INTACT MX 50 oil	page 29/part A
Charge the ICU battery	page 25/part A
Store your JetSurf™ with the open engine cover	

WATER REMOVAL FROM THE FLOODED ENGINE

Although the JetSurf™ is equipped with systems for removing water from the power board, it can happen that some water gets into the engine compartment and then it floods the engine through or exhaust. In such a case, the JetSurf™ will not start and it will be necessary to remove the water from the engine.

PROCEDURE

1) Take the holder from the spark plug boot - FIGURE 1 and remove the boot from the spark plug - FIGURE 2. Screw the spark plug out using a spark plug spanner which is supplied within the accessories. Dry the spark plug properly. If the spark plug has been in operation for more than 6 hours, it should be replaced.

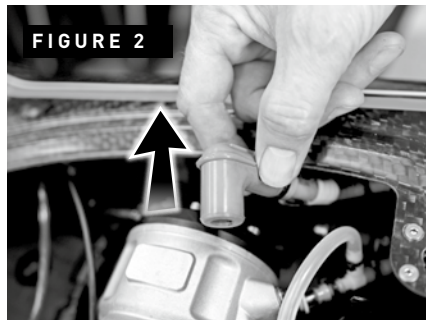
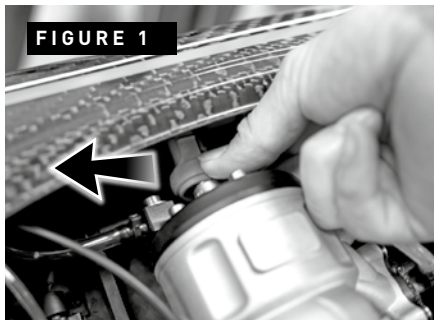

2) Tilt the JetSurf™ towards the spark plug opening down (its head engine). When the spark plug screwed out, start turning the shaft with your hand. While turning the shaft, you should see water coming out head engine. Continue until water stops coming out.

3) If no more water is coming out of the engine head, place and keep the key on the indicator - FIGURE 3. When the shut-off key is placed, the starter starts turning without ignition on the spark plug. Continue turning the engine until only fuel is splashing out of the spark plug opening (fuel and water form a white emulsion).



ATTENTION: The third point can only be performed if most of the water has already been pumped out manually or otherwise there is a danger of damage to the starter. Do not turn the starter longer than 10 seconds.

4) Screw the spark plug back in following the instructions in the section Spark plug.

5) Put the spark plug boots back in place and secure it with a boot holder.

6) Start the engine for maximum 5-10 seconds to make sure that it works correctly. The engine should not be run without cooling for more than 10 seconds (temperatures of cylinder shouldn't be higher than 65°C/147°F) or otherwise it can get overheated and damage.



Never insert the engine shut-off key in the handle when the spark plug is out.

Make sure that the boot covers the spark plug completely when mounted.

4A STORAGE

SHORT-TERM STORAGE

For short-term storage, for example between the individual days of riding, it is sufficient to follow the steps described in the chapter on page 36/part A "AFTER THE RIDE". After these steps have been performed, store the JetSurf in a dry place.

LONG-TERM STORAGE

If the break is longer than one week, it is necessary to perform other tasks. Do not underestimate these steps. Keep in mind that if you look after the JetSurf properly, you will increase the life of all its parts.

For at least 3 days always start the engine and accelerate several times.

Take the fuel tank out of the board. Pour all fuel out of the fuel tank and clean it thoroughly.

Never store the Jetsurf with fuel in the tank.

Always once in every 6 months, grease all the engine parts with MOTOREX INTACT MX 50 spray.

In winter or when JetSurf is not used, it is necessary to charge the battery in ICU at least once in every 3 months. For battery charging, see page 25/part A.

Check grease in the freewheel, see page 44/part A Freewheel.

Store your JetSurf™ with the open engine cover.



WE STRONGLY RECOMMEND PERFORMING ALL THESE STEPS. NOT PERFORMING THESE STEPS LEADS TO SIGNIFICANT SHORTENING OF THE PRODUCT LIFE OR IN EXTREME CASES TO IRREVERSIBLE DAMAGE TO JETSURF.

5A TRANSPORT



NEVER TRANSPORT JetSurf™ WITHOUT FIRST EMPTYING AND CLEANING THE FUEL TANK. FUEL CAN BE REMOVED ONLY ON-SHORE AND PROPERLY AS DESCRIBED IN THE FUEL SECTION OF THIS OWNER'S MANUAL PAGE 12, part B and page 28 part A). TRANSPORTING FUEL CAN BE DANGEROUS AND MAY BE ILLEGAL IN SOME JURISDICTIONS.

Before transporting the power board, make sure that there is no water in the exhaust system. It could get into the engine during the transport (see the chapter After the ride).

Always unscrew both side and main fins (if they are included).

NOTE: If you have a two-part main fin, you can keep the platform on the board and unscrew only the spike.

ALWAYS TRANSPORT JETSURF™ WITHOUT THE FUEL TANK INSIDE THE BOARD.

AIR TRANSPORT

Airline companies do not like fuel in luggage and may refuse to transport your power board. Therefore it is **ABSOLUTELY NECESSARY** to wash the fuel tank completely before air transport of your power board. Wash the tank with water and detergent. Repeat washing as long as you can still smell petrol from the fuel tank.

Before air transport also check the excess pressure tube (blue tube coming out of the fuel tank to the snorkel outlet in the board tip), there can be traces of fuel there. If there are remnants of fuel in the tube, wash this tube out. Also clean the carburettor.

GENERALLY, YOU SHOULD NOT SMELL FUEL FROM THE BAGGAGE.

ALWAYS TRANSPORT JETSURF™ WITHOUT THE ICU INSIDE!

Please be aware of how airline companies treat the luggage. Despite its solidity, carbon is still quite a brittle material and therefore it is not enough to pack the power board in the original Jetsurf bag but you have to add other protection layers.

TRANSPORT TO SERVICING

Before transport, place the power board in the original board bag and add further protection layers (for example wrap the board bag with the power board in bubble wrap and wrap it all in stretch foil or insert the bag in a carton box).

Apart from a name tag and contact details, we recommend enclosing a detailed description of the problem when sending the JetSurf for service.

Note: If you are sending your Jetsurf to servicing back to your dealer or directly to the manufacturer, you do not have to send all the accessories together with the power board (e.g. the tank, fins or charger...).

WE RECOMMEND TO CONTACT AND COMMUNICATE WITH A SERVICE POINT FIRST!

6A MAINTENANCE

Although JetSurf™ manufacturer uses the highest quality materials available for production of the motorized power board, the user has to perform regular maintenance which will ensure long-term life and high gloss for which it was so sought after when purchased. Failure to observe these instructions may result in the premature damage to the motorized power board which is not covered by the guarantee.

Always perform due maintenance of your motorized power board and be aware that its condition may deteriorate with time and as a result of demanding operation or bad handling.

A basic precondition of good maintenance is observing of procedures described in the chapters "AFTER THE RIDE" on page 36/part A and in the chapter "LONG-TERM STORAGE" on page 40/part A.

SURFACE MAINTENANCE

Maintaining a top layer of quality wax on the surface of the motorised power board is crucial for keeping of the original high gloss surface for years to come. Use only high quality wax, such as carnauba wax. Failure to protect this top layer can make the guarantee void.

MAINTENANCE OF TECHNICAL EQUIPMENT

Check the technical equipment of the engine compartment regularly in order to prevent bigger damage to the power board. If any damage occurs on any part of the power board or if you are not sure whether your power board is in order, please contact your authorised JetSurf™ Authorized Dealer.

ENGINE MAINTENANCE

Before and after every ride always grease all the engine parts with the MOTOREX INTACT MX 50 spray. If you do not use your JetSurf for a long time, follow the instructions specified in the chapter LONG-TERM STORAGE, 40/part A. Once in every 12 months we recommend performing a complete service inspection.

MAINTENANCE OF SPARK PLUG

The spark plug must be checked before every ride and for a trouble-free power board operation it must be replaced after 6 hours of operation.

Use only the spark plug specified in this manual NGK BPR 7HS. These spark plugs can be purchased online or in shops selling car parts.



NOTICE

Using any other type of a spark plug may result in the engine damage and will make the guarantee void. Although some companies may claim that they have an equivalent spark plug, JetSurf™ strongly recommends the customers to use only spark plugs of NGK brand. Using any spark plugs other than NGK may lead to the engine damage and will make the guarantee void.

When installing a new spark plug, tighten it with a spanner according to the instructions on the spark plug packaging.



WARNING

After removing the boot from the spark plug, NEVER start the engine in a standard way. If the engine is started without having the boot mounted on the spark plug screwed in the engine, it may result in damaging of the ignition control unit (ICU).

In order to ensure proper engine operation, the spark plug must be placed correctly between the electrodes and it must be kept clean.

CHECK OF THE SPARK PLUG

When the spark plug is removed, you can check it visually. If the insulator is highly worn or if you can see any scratches or cracks on it, replace the spark plug.

Using a shim gauge, you can measure the gap between the electrodes of the spark plug. For NGK BPR 7HS this gap should be 0.7 – 0.8 mm.

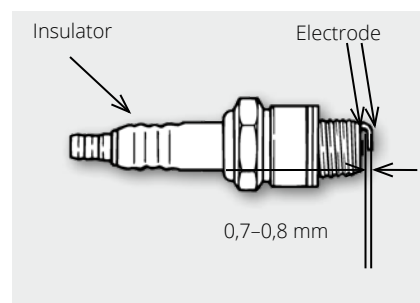

SPARK PLUG REPLACEMENT



Warning – high voltage on the spark plug boot.

Never remove the boot from the spark plug when the ignition is switched on (the indicator is not on or flashing).



WARNING

Do not remove the boot from the spark plug if there is water in the engine compartment.

When working in the engine compartment, DO NOT to handle fire.

After the boot has been removed from the spark plug, NEVER START THE ENGINE – if the engine was started without a mounted spark plug boot, it would damage the control unit.

PROCEDURE:

- Before every assembly, remove the tank: disconnect the hoses and undo the velcro with which the tank is attached.
- Check the engine, if it is not too hot. We recommend performing the assembly minimum 0.5 hours after the engine was switched off.
- Check whether the ICU control unit is not on (the indicator is not lit or flashing)!

Required tools: spark plug spanner supplied by the manufacturer (accessories) - 21 mm.

- 1) Take off the holder from the spark plug boot – FIGURE 1.
- 2) Remove the spark plug boot – FIGURE 2.
- 3) Screw the spark plug out using a spark plug spanner – FIGURE 3 and 4.

MAINTENANCE

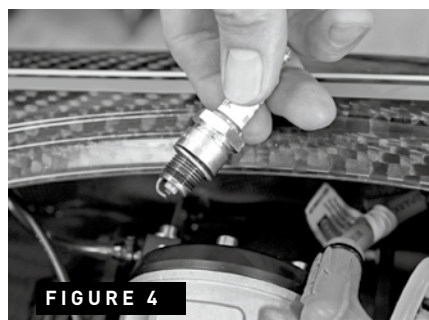
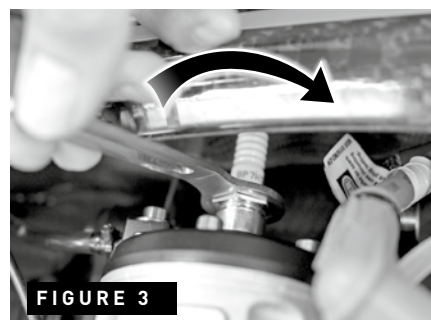
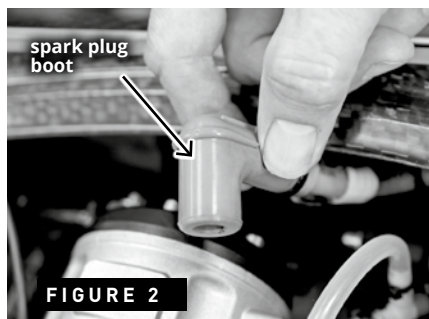
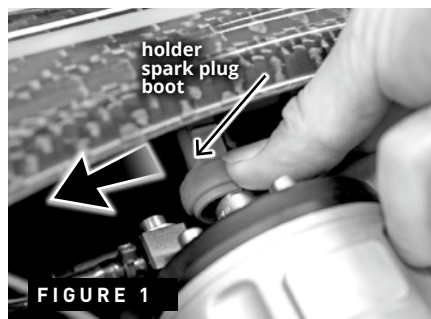

4) Using a gauge check the gap between the electrodes on the new spark plug. If necessary, adjust the gap by slightly bending the electrode. The gap should be 0.7 – 0.8 mm.

5) Insert a new spark plug in the seat, **FIRST SCREW THE SPARK PLUG IN USING YOUR HAND** to prevent damaging of the thread. When the spark plug is in the seat, tighten it carefully with a spark plug spanner. If the spark plug is brand new, tighten it with a spanner by 2/3 of a turn. If the spark plug has been used before, tighten only by 1/8 – 1/4 of a turn.

WHEN TIGHTENING THE SPARK PLUG, FOLLOW THE INSTRUCTIONS FROM THE SPARK PLUG MANUFACTURER!

6) Mount the boot on the spark plug. The boot is mounted correctly if the spark plug insulator is fully covered by the boot.

7) Place the boot holder on the spark plug boot.

MAINTENANCE OF ELECTRIC BILGE PUMP

The bilge pump sucks water from the internal area of JetSurf™. It is a vital part for the JetSurf operation. During every ride, check whether the pump works properly. Keep the suction filter clean.

SUCTION FILTER CLEANING PROCEDURE:

Required tools: key TORX No 20

1) Unscrew the screw holding the bilge pump - FIGURE 1.

MAINTENANCE

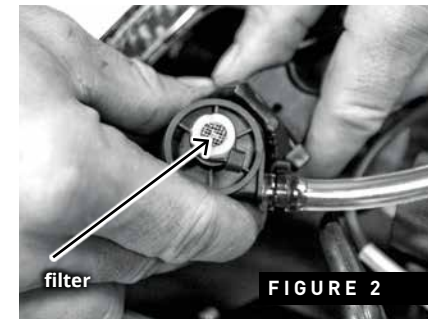
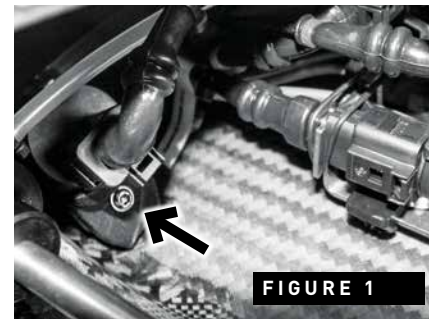

2) With a slight upward lift, pull out the bilge pump.

3) Clean the bilge pump filter - FIGURE 2.

4) Put the bilge pump back and screw in the screw again.

EXHAUST SILENCER MAINTENANCE

Before every ride, apply conservation spray in the inner part of the silencer - e.g. MOTOREX INTACT MX 50, chapter BEFORE YOU START.

After every 10 MH clean the exhaust silencer.

SILENCER CLEANING PROCEDURE:

What you need: degreaser and a cloth

1) Loosen the nut - FIGURE 1 and remove the silencer from the exhaust.

2) Remove the spring and valve from the exhaust - FIGURE 2.

3) Clean all the removed parts thoroughly.

4) Reinstall the valve, spring and silencer and tighten the nut.

Attention: The spring has a conic shape. The valve therefore has to be attached at the side with the bigger diameter. The spring side with the smaller diameter is to be placed to the recess in the cover.

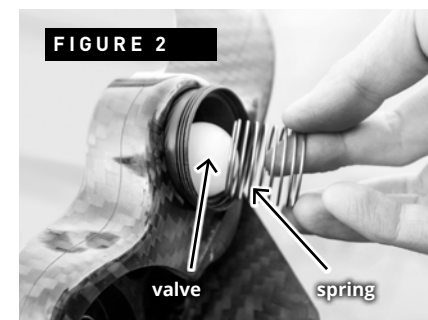
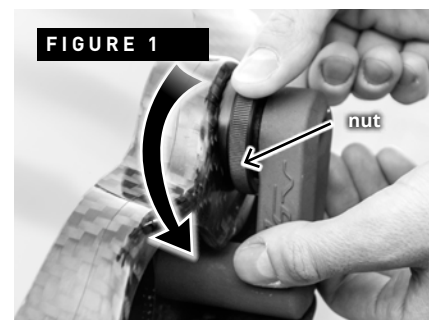

TABLE OF REGULAR MAINTENANCE

Item	Operation	Before every ride	After every ride	Every 10 MTH	Every 25 MTH	Every 3 months	Every 6 months (before storage)	Page
Spark plug	check / cleaning	x						43/part A
	replacing			x				43/part A
Spark plug boot	check	x						42/part A
Connections, tubes, connecting material and cables, connectors	check	x						
Board	washing with fresh water, drying		x					
All the engine parts	washing with fresh water, drying		x					
	lubrication with MOTOREX INTACT MX 50 spray	x	x				x	29/part A
Throttle control and fuel system	check	x						24/part A
Check/tighten the engine fastening screws	check/tightening					x		
Jet pump impeller	check		x					
ICU battery	charging	x	x			x		25/part A
Cooling system/tubes	check	x						
Bilge pump	check	x						
	cleaning			x				45/part A
exhaust silencer	lubrication	x						29/part A
	cleaning			x				45/part A

Every 12 months a complete service inspection is highly recommended.

7A WARRANTY

Effective from -----

2019

Section 1. Limitations and Disclaimer of Implied Warranties.

ANY IMPLIED WARRANTY THAT IS FOUND TO ARISE BY STATE OR FEDERAL LAW*, INCLUDING ANY IMPLIED WARRANTY OF MERCHANTABILITY OR ANY IMPLIED WARRANTY OF FITNESS, IS LIMITED IN DURATION TO THE DURATION SET FORTH IN THIS LIMITED WARRANTY OR THE DURATION SET FORTH BY APPLICABLE STATE OR FEDERAL LAW, WHICHEVER IS SHORTER. JetSurf™ DISCLAIMS ANY IMPLIED WARRANTIES, OR REPRESENTATIONS OF ANY KIND, INCLUDING ANY IMPLIED WARRANTY OF MERCHANTABILITY OR ANY IMPLIED WARRANTY OF FITNESS, AFTER EXPIRATION OF THE WARRANTY PERIODS APPLICABLE TO THE RESPECTIVE COMPONENTS.

PERFORMANCE OF REPAIRS AND NEEDED ADJUSTMENTS IS THE EXCLUSIVE REMEDY UNDER THIS WRITTEN WARRANTY, WITHOUT EXCLUSION, MODIFICATION OR RESTRICTION OTHER THAN UNDER APPLICABLE LAW. JetSurf™ SHALL NOT BE LIABLE FOR INCIDENTAL OR CONSEQUENTIAL DAMAGES, SUCH AS, BUT NOT LIMITED TO, LOST WAGES, TRANSPORTATION TO OR FROM REPAIR, OR RENTAL EXPENSES, RESULTING FROM BREACH OF THIS WRITTEN WARRANTY OR ANY IMPLIED WARRANTY.

SOME STATES DO NOT ALLOW LIMITATIONS ON TIME LIMITS OR EXCLUSIONS OF INCIDENTAL OR CONSEQUENTIAL DAMAGES, SO THE ABOVE LIMITATIONS MAY NOT APPLY TO YOU. THIS LIMITED WARRANTY GIVES YOU SPECIFIC LEGAL RIGHTS WHICH MAY VARY FROM STATE TO STATE, IN DIFFERENT JURISDICTIONS AND GEO-POLITICAL REGIONS.

Section 2. The Limited Warranty Application and Terms.

JetSurf™ ("JetSurf")*, subject to all other terms, conditions, and limitations, warrants to the original owner(s) of the boat who purchase(s) the boat within twelve (12) consecutive months of the earlier of (a) the date purchased by the first retail purchaser through an authorized JetSurf™ Sales facility, or (b) the date the boat was first put into service as a demonstrator or otherwise, and qualify for warranty coverage as explained below, are provided coverage under the JetSurf™ Limited Warranty.

JetSurf™ warrants to the original purchaser that the motorized surfboard is free from material defects and workmanship to the extent set forth below.

Regulations in some countries specify that emissions-related components are subject to warranty periods exceeding the twelve (12) month limited warranty that applies to the motorized surfboard in general. Emission-related components that are installed on EPA certified JetSurf™ motorized surfboards registered in the USA are covered for a period of thirty (30) consecutive months from the date the motorized surfboard is placed in service; and evaporative emission related components are warranted for twenty-four (24) consecutive months. Additional information is provided in Section 4: Emissions Control.

Please refer to the warranty details that follow for complete terms, conditions and limitations. All warranty applications are dependent upon the purchaser following the guidelines established for appropriate care and maintenance, and when operated reasonably and as directed in this Owner's Manual and any additional material provided by JetSurf™.

* Valid for the USA

WARRANTY

For a period of twelve (12) consecutive months as established above, JetSurf™ will repair manufacturing defects related to structural materials or workmanship which occurred during the construction of the surfboard and engine. All repairs performed by JetSurf™, or its authorized service facilities, will be performed using either new or re-manufactured parts at JetSurf's sole discretion and, JetSurf™ may, at its sole discretion, install parts which have similar or greater performance characteristics if an identical replacement part is no longer available.

A repair shop of the owner's choosing may maintain, replace, or repair non-warranty emission control devices and systems.

The JetSurf™ Limited Warranty is transferable to subsequent owners per the instructions in Section 6.6.

Section 3. Warranty Exclusions and Limitations.

Conditions may exist outside of JetSurf™'s control, which may exclude or limit the scope of the warranty statement.

The following are NOT covered under the JetSurf™ Limited Warranty:

- normal maintenance components and materials required under the JetSurf™ Limited Warranty;
- normal wear-and-tear of any component, engine or the power board;
- damages caused by defects in materials, components or parts not supplied by JetSurf™ ;
- damages or needed adjustments caused by items that are added, altered or changed after the board leaves the possession of JetSurf™, as well as any modification, alteration, unauthorized repair or replacement of components, engine or surfboard after the retail owner takes possession of same;
- damages caused by accident (including impacts and collisions with any object), neglect, negligence, mishandling, abuse or misuse, or alteration, including any damages caused during transportation of the JetSurf™ motorized surfboard;
- damages caused by heat, fire, explosion or freezing (including the failure to perform proper winterization or preparations for storage;
- damages resulting from vandalism;
- damages caused by lightning, hail, rain, flooding, wind, sand, floods or other environmental or natural conditions or Acts of God;
- damages caused by cleaning products not specifically approved by JetSurf™;
- damages due to insufficient or improper maintenance;
- damage resulting from leaking or spilled fluids including, but not limited to, fuel or drive train fluids;
- conditions resulting from use of the board for anything other than recreational purposes;
- any material, component or part of the board that has a warranty period and/or conditions as specified by the producing entity which differs from the general JetSurf™ warranty statement
- damage or injury resulting from failure to comply with recall notices or requests from JetSurf™ to repair the board or its components;
- failure to properly maintain and care for the board and its components in accordance with the instructions found within this Owner's Manual.

WARRANTY

No one, including dealers, agents, distributors or suppliers is authorized to create a warranty or in any manner increase or modify the scope of this JetSurf™ Limited Warranty in any manner whatsoever.

This JetSurf™ Limited Warranty requires, where allowed by law, the timely completion and return of the warranty registration card to JetSurf™.

The warranty statement exists between the original retail and JetSurf™. No rights are transferred to any third party. Within the specified, stated warranty period and under all circumstances, the entire liability of JetSurf™ is limited to the repair or replacement of any defective component or affected portion of the motorized surfboard, or the actual price paid for the motorized surfboard. Some jurisdictions do not allow the exclusion or limitation of liability, so the above statement may not apply.

Section 4. Emissions Control

Section 4.1 General Requirements. Specific warranty requirements may be designated by governmental and regulatory agencies. Consistent with governmental obligations JetSurf™ warrants the motorized surfboard to the retail purchaser, that the product is designed, built, and equipped so as to conform at the time of sale with applicable regulations, and that the engine is free from defects in materials and workmanship which cause the engine to fail to conform with applicable regulations. Emissions warranty is subject to the requirements as specified in the location of the original owner(s) OR the location in which the primary operation of the motorized surfboard will be. It is the responsibility of the owner(s) to ensure that the emissions requirements are met for proper operation of the motorized surfboard.

Section 4.2 California Emissions.* California residents who purchased or warranty-registered a Product in California should refer to Jetsurf's California Emissions Control Warranty Statement

Section 4.3: Emissions-related Components Covered by EPA and California Emission Warranty:

Carburetor	Fuel Tank
Spark Plug	Fuel Cap
Ignition Control Unit (ICU)	Fuel lines
Intake and exhaust valves	Fuel line connectors and clamps
Exhaust Manifold	Fuel Pump
	Fuel Filter

Section 5. Product Change.

JetSurf™ reserves the right to implement changes in construction or components at any time without incurring any obligation to make the same or similar changes on motorized surfboards previously built and/or sold.

Section 6. Customer Satisfaction.

Section 6.1. Procedure. Any matters regarding potential corrections as applicable under this JetSurf™ Limited Warranty should first be addressed with an authorized JetSurf™ dealer. While it is not a requirement to contact the original-purchase dealer, JetSurf™ encourages consumers to do so. First contact should be with the dealer's Service department. If satisfaction is not achieved, consumer should then contact dealer Management.

Section 6.2. Arbitration. TO THE EXTENT PERMITTED OR REQUIRED BY ANY STATE OR FEDERAL LAW, YOU ARE REQUIRED TO PROVIDE JetSurf™ WRITTEN NOTICE, AT THE BELOW ADDRESS, OF ANY

* Valid for the USA

WARRANTY

SUBSTANTIAL DEFECT IN MATERIALS OR WORKMANSHIP THAT REMAINS UNRESOLVED TO YOUR SATISFACTION UNDER THE TERMS OF THE JetSurf™ LIMITED WARRANTY, PRIOR TO INITIATING ANY LEGAL ACTION AGAINST JetSurf™. TO THE EXTENT PERMITTED OR REQUIRED BY ANY STATE OR FEDERAL LAW*, YOU MUST FIRST USE AN AVAILABLE STATE-RUN INDEPENDENT DISPUTE SETTLEMENT MECHANISM OR ARBITRATION MECHANISM PRIOR TO INITIATING ANY LEGAL ACTION AGAINST JetSurf™.

Section 6.3. Warranty Terms and Conditions (Australia). ** Nothing in these warranty terms and conditions can exclude, restrict or modify the application of any condition, warranty, guarantee, right or remedy conferred or implied under the Competition and Consumer Act 2010, including the Australian Consumer Law or any other law, where to do so would contravene that law, or cause any part of these terms and conditions to be void. The benefits provided under this limited warranty are in addition to other rights and remedies under Australian law.

This motorized surfboard comes with guarantees that cannot be excluded under the Australian Consumer Law. You are entitled to a replacement or refund for a major failure and for compensation for any other reasonably foreseeable loss or damage. You are also entitled to have the goods repaired or replaced if the goods fail to be of acceptable quality and the failure does not amount to a major failure.

Section 6.4. Warranty Claims. To obtain warranty service and/or repairs, notify an authorized JetSurf™ service facility of the substantial defect in materials or workmanship attributable to JetSurf™, within 90 days of discovery of the defect; and schedule an appointment. Deliver the motorized surfboard and/or engine to an authorized JetSurf™ service facility for repairs. Warranty service must be performed by an authorized JetSurf™ dealer. For assistance in locating an authorized JetSurf™ service facility, please visit JetSurf™ website at

www.jetsurf.com
or call JetSurf™ at +420 774 60 27 01
Monday-Friday 8:00 - 18:00 CET

JetSurf™-authorized repair facilities are independently owned and operated businesses. JetSurf™ cannot control the scheduling of service work.

Section 6.5. Change of Address. In the event of a change of address for the original owner(s) of the motorized surfboard, please notify an authorized JetSurf™ dealer.

Section 6.6. Transfer of Ownership. If the ownership of a product is transferred during the warranty coverage period, this warranty shall also be transferred and be valid for the remaining coverage period provided that JetSurf is notified of such transfer of ownership in the following way: The former owner contacts JetSurf (at the phone number provided below) or an authorized JetSurf dealer and provides the a copy of the bill of sale or purchase agreement, as well as the new owner's name, address and product serial number.

Section 6.6. Direct Contact.

MSR Engines s.r.o.
 Krásného 3857/7; 636 00 Brno, Czech Republic
 Internet Site www.jetsurf.com

THIS WARRANTY GIVES YOU SPECIFIC LEGAL RIGHTS, AND YOU MAY ALSO HAVE OTHER LEGAL RIGHTS WHICH VARY FROM STATE TO STATE AND IN DIFFERENT GEO-POLITICAL REGIONS.

* It applies to the USA; ** It applies to Australia

TROUBLESHOOTING

8A TROUBLESHOOTING



IF THE POWER BOARD OWNER DOES NOT HAVE SUFFICIENT EXPERIENCE OR IS IN ANY DOUBTS REGARDING THEIR ABILITY TO PERFORM THE REPAIR, IT IS NECESSARY TO LEAVE THE REPAIR TO THE QUALIFIED MECHANICS OF JetSurf™ COMPANY WHO HAVE BEEN TRAINED BY THE MANUFACTURER AND ARE CERTIFIED FOR IT.

ISSUE	Defect, symptoms	REPAIR – step 1	REPAIR – step 2
The power board does not start, the engine turns	Water in the engine - symptoms: <i>white emulsion on the spark plug</i>	Clean the spark plug, p. 43/part A	Clean the engine, p. 38/part A
	Too much fuel in the engine - - symptoms: <i>the spark plug is soiled with petrol</i>	Clean the spark plug, p. 43/part A	Replace the carburettor
	No fuel in the engine - symptoms: <i>dry spark plug, empty fuel tubing</i>	Check the fuel system	Refill the fuel
	Faulty spark plug - symptoms: <i>the spark plug does not spark</i>	1. Replace the spark plug, p. 43/part A	If implementing of 1 and 2 did not help, try a new coil and ICU
	Faulty timing sensor - symptoms: <i>the spark plug sparks after the engine shut-off key is pulled out</i>	2. Replace the timing sensor	
The power board does not start, the engine does not turn, the ICU does not flash	Flat battery	Charge the battery, p. 25/part A	
	Faulty contact in the cables of the control handle	Clean the contacts	Replace the control handle
	The relay in the control handle does not detect the engine shut-off key		
	Damaged ICU cable	Replace the ICU	
Faulty ICU	Replace the ICU		
The power board does not start, the engine does not turn, the ICU flashes	Burnt starter winding	Replace the starter	
	Jammed engine or stuck jet pump	Replace the Engine or jet pump	





Do not remove the boot from the spark plug if there is water or leaked petrol in the engine compartment. Pay special attention to petrol vapours. If you can smell petrol, NEVER start the engine.

When checking the spark plug and timing sensor function, ALWAYS use a mounting tool supplied by JetSurf™ in the accessories to check the sparks.

TROUBLESHOOTING

SIGNALLING OF IGNITION CONTROL UNIT (ICU) FAULTS

The errors are signalled by the indicator situated at the engine cover.

	■■■■■■■■■■	The indicator is lit		————	The indicator is not lit				
Course of signalling	————	■■■■■■■■■■	————	■■	————				
Fault type/cause	When the engine shut-off key was inserted in the handle for the first time, it stayed in the handle for longer than 30 seconds.								
How to repair it	Pull the key out.								
Course of signalling	————	■■■■■■■■■■	————	■■	——	■■	——	■■	——
Fault type/cause	Low battery – it can be caused by a short circuit of the starter or flat battery.								
How to repair it	Charge the battery. Starter replacement – if the batteries are charged and the starter turns slowly.								
Course of signalling	————	■■■■■■■■■■	————	■■	——	■■	——	■■	——
Fault type/cause	Fault of electric bilge pump – a short circuit of the pump has been detected but the ignition works normally after that.								
How to repair it	Check the conductor to the pump, clean the pump or replace it.								
Course of signalling	————	■■■■■■■■■■	————	■■	——	■■	——	■■	——
Fault type/cause	Fault of excessive use of the starter – there have been 10 starts without the engine getting started, this signalling will last 2 minutes.								
How to repair it	Wait for 2 minutes.								
Course of signalling	————	■■■■■■■■■■	————	■■■■■■■■■■	————	■■■■■■■■■■	————	■■■■■■■■■■	————
When the ignition control unit (ICU) is switched off, it switches off automatically after 5 minutes of idleness.									

TROUBLESHOOTING

CHECK OF THE SPARK PLUG AND TIMING SENSOR FUNCTION



Be careful, there is high voltage on the spark plug boot. Never remove the boot from the spark plug

when the ignition is on (the indicator is not on or flashing).

Do not remove the boot from the spark plug if there is water or leaked petrol in the engine compartment. Be very careful about petrol vapours. If you can smell petrol, NEVER start the engine.

When working in the engine compartment, do not to handle fire.

WHEN CHECKING THE SPARK PLUG AND TIMING SENSOR FUNCTION, ALWAYS USE THE MOUNTING TOOL SUPPLIED BY JETSURF™ WITH THE ACCESSORIES FOR TESTING THE SPARKS.

PROCEDURE:

– Check that the engine is not hot. We recommend performing the assembly minimum 0.5 hours after the engine is switched off.

– Check that the ICU control unit is not on (the indicator is not on or flashing!)

Required tools: spark plug spanner supplied by JetSurf™ (accessories) - 21 mm.

CONNECTING THE MOUNTING TOOL FOR SPARK PLUG TESTING

- 1) Remove the boot holder from the spark plug boot and remove the boot.
- 2) Screw the spark plug out using a spark plug spanner. Check the spark plug and possibly dry it.
- 3) Insert the spark plug back into the spark plug boot - FIGURE 1.
- 4) Place the cap on the top of the spark plug (electrode) - FIGURE 2.
- 5) Attach the big crocodile clip on the metal part of the spark plug - FIGURE 3.
- 6) Attach the small crocodile clip on the ground cable eye terminal - FIGURE 4.
- 7) Disconnect the 2-pin connector (marked with a red cable tie) - FIGURE 5.

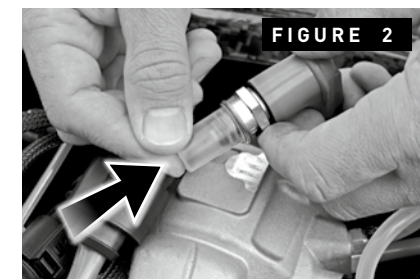
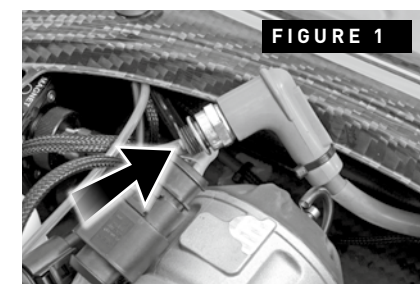
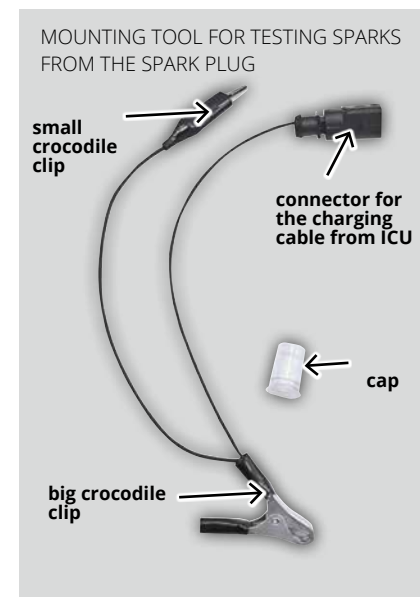

TROUBLESHOOTING

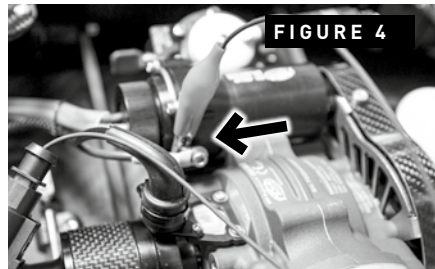
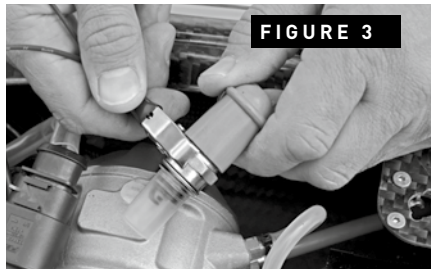

CHECK OF THE SPARK PLUG AND TIMING SENSOR FUNCTION

8) Insert the key in the switch in the control handle for approx. 5 seconds (you should hear the sound of the pump). Remove the key.

9) After 3 seconds reinsert the key in the engine shut-off switch (the starter switches on). Under the cap of the mounting tool you should see a spark on the spark plug electrode.

Remark: In daylight it may be more difficult to see the spark. It does not have to be one spark but you can see more tiny sparks.

Warning: **The spark test can be repeated maximum ten times. Overusing the starter may cause its overheating and damaging.**

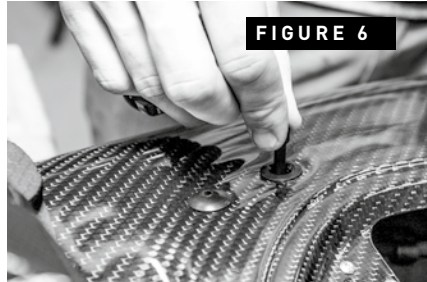

DIAGNOSTICS

A) If the spark plug does not spark, proceed according to the table on page 51 - TROUBLESHOOTING, 1st line highlighted dark.

B) If the spark plug sparks after the engine shut-off key is pulled out, proceed according to the table on page 51 - TROUBLESHOOTING, 2nd line highlighted dark

10) Switch off the ICU by placing the shut-off key to the indicator – FIGURE 6.

11) Remove the mounting tool – disconnect both crocodile clips, disconnect the connector for the ICU charging and insert the connector in the blind plug, remove the cap from the spark plug.

12) Remove the plug from the boot and if it is not faulty, insert it back in the engine seat. **FIRST SCREW THE SPARK PLUG IN BY HAND** in order not to damage the thread. When the spark plug is in the seat, tighten it carefully with a spark plug spanner. If the spark plug is brand new, tighten it with a spanner by 2/3 of a turn. If the spark plug has been used before, tighten it only by 1/8 –

TROUBLESHOOTING

1/4 of a turn. **WHEN TIGHTENING THE SPARK PLUG, FOLLOW THE INSTRUCTIONS FROM THE SPARK PLUG MANUFACTURER!**

13) Place the boot on the spark plug. The boot is mounted correctly when the spark plug insulator is covered completely with the boot.

7) Place the boot holder on the spark plug boot.

WARNING: When the boot has been removed from the spark plug, NEVER START THE ENGINE – if the engine is started without the spark plug boot on, the control unit will be destroyed.

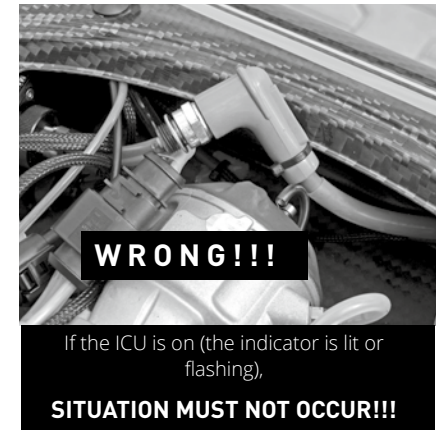



Československý Lloyd
Notified Body 2371

EU-TYPE - EXAMINATION CERTIFICATE (MODULE B)
No. 5739103

This is to certify that Československý Lloyd has undertaken the relevant examination procedure according to the Directive 2013/53/EU and the conformity assessment "Module B", described in Annex II of the Decision No 768/2008/EC of the European Parliament and of the Council, and that the recreational craft/product identified below was found to comply with the relevant requirements.

MANUFACTURER: **MSR Engines s.r.o.**
Krásného 3857/7, 636 00 Brno

PRODUCT DESCRIPTION: **Inboard two-stroke spark ignition engine with inboard exhaust system designed for JETSURF**

PRODUCT DESIGNATION: **ENGINE MSR NG100 DFI**

The certificate is valid only for the product specified in this certificate.
Product shall be marked with the identification number of the Notified Body 2371.



V 3099



18.12.2018, Prague
Date, Place of issue



Ing. Jiří Dynybyl
CS Lloyd

Terms and validity conditions:
The product liability rests with the manufacturer, his representative or, in the absence of a representative, the importer, in accordance with the General Product Safety Directive 2001/95/EC and Recreational Craft Directive 2013/53/EU.
The following conditions may render this document invalid:
- Changes in construction of the product as regards the examined technical file.
- Changes or amendments to the RCD.
- Changes or amendments in the standards with form basis for documenting compliance with the essential requirements of the RCD.

validity code: CAB3279F-F27
Check validity of the certificate using this code on www.csloyd.com.

CS Lloyd, spol. s r.o., Pobežní 620/3, Prague, Czech Republic

Page 1 of 2 F-509A (R0)

Cert. No. 5739103

Description of product:	ENGINE MSR NG100 DFI
--------------------------------	-----------------------------

Engine power:	7,2 kW / 9,7 HP
Rated engine speed:	7250 rpm
Fuel type:	Premixed petrol-oil mixture (50:1)
Engine displacement:	100 cm³
Combustion type:	Spark ignition
Combustion cycle:	Two stroke
Applied standards:	EN ISO 18854-1:2015

Notes:
Reviewed without comment.



Technical documentation
Technical Report No.: 41286 – 18 – TAC.

Applied Standards
Directive 2013/53/EU, Annex I.

Terms and conditions
The Certificate is concerned with the type design of the product only. To meet the requirements of the Directive and legally to provide the CE mark on the actual product, the manufacturer shall assess the product and/or the production according to one of the following procedures and issue the final Declaration of Conformity:
- Conformity to type (Module C)
- Production quality assurance (Module D)
- Product quality assurance (Module E)
- Product verification (Module F).

The manufacturer must be also aware that in case, the equipment of the watercraft has to be in compliance with other EU legislative requirements (other Decisions and Directives), this is the duty of the manufacturer to meet this requirement.

Page 2 of 2 F-509A (R0)

	UNITED STATES ENVIRONMENTAL PROTECTION AGENCY 2019 MODEL YEAR CERTIFICATE OF CONFORMITY WITH THE CLEAN AIR ACT	OFFICE OF TRANSPORTATION AND AIR QUALITY ANN ARBOR, MICHIGAN 48105
Certificate Issued To: MSR Engines s.r.o. (U.S. Manufacturer or Importer) Certificate Number: KMSEMO100E2-001	Effective Date: 02/08/2019 Expiration Date: 12/31/2019	 Byron J. Bunker, Division Director Compliance Division
Manufacturer: MSR Engines s.r.o. Engine Family: KMSEMO100E2 Useful Life: 350 Hours / 3 Years FELS: Emission Standards: HC + NOX (g/kWhr) : 23.9 CO (g/kWhr) : 462.9	<p>Pursuant to Section 213 of the Clean Air Act (42 U.S.C. section 7547) and 40 CFR Part 1045, 1065, 1068 and subject to the terms and conditions prescribed in those provisions, this certificate of conformity is hereby issued with respect to the test engines which have been found to conform to applicable requirements and which represent the following marine engines, by engine family, more fully described in the documentation required by 40 CFR Part 1045 and produced in the stated model year.</p> <p>This certificate of conformity covers only those new marine spark-ignition engines which conform in all material respects to the design specifications that applied to those engines described in the documentation required by 40 CFR Part 1045 and which are produced during the model year stated on this certificate of the said manufacturer, as defined in 40 CFR Part 1045. This certificate of conformity does not cover marine engines imported prior to the effective date of the certificate.</p> <p>If applicable, this certificate of conformity is conditional upon compliance of said manufacturer with the averaging, banking and trading provisions of 40 CFR Part 1045, Subpart H. Failure to comply with these provisions may render this certificate void <i>ab initio</i>.</p> <p>It is a term of this certificate that the manufacturer shall consent to all inspections described in 40 CFR Part 1068.20 or authorized in a warrant or court order. Failure to comply with the requirements of such a warrant or court order may lead to revocation or suspension of this certificate for reasons specified in 40 CFR Part 1045. It is also a term of this certificate that this certificate may be revoked or suspended or rendered void <i>ab initio</i> for other reasons specified in 40 CFR Part 1045.</p> <p>This certificate does not cover marine nonroad engines sold, offered for sale, or introduced, or delivered for introduction, into commerce in the U.S. prior to the effective date of the certificate.</p>	



CERTIFICATE

Certification Body for certification of management systems
accredited by ČIA according to ČSN EN ISO/IEC 17021:2016

CERT QUALITY s.r.o.

confirms that the company

MSR Engines s.r.o.

Krásného 3587/7
636 00 Brno – Židenice

for fields of activities:

Development, production and sales of Spark-ignition engines, ignition systems, machinery and device

has established and applies an Quality Management
Systems in accordance with the standard

ČSN EN ISO 9001:2016



Certificate validity till: 25.09.2020
Certificate No: 1112017



S 3221

26.10.2017

Date of the certificate issue





Head of Certification Body
CERT QUALITY s.r.o.

Further information regarding the scope of this certificate can be obtained from the organization
CERT QUALITY s.r.o., Jihlavská 268/11, 750 02 Olomouč, IČ: 27891844
The company is registered in the C.R. Register in Olomouč department C.000511131



To whom it may concern at WestJet Airlines Ltd.,

JetSurf/MSR Engines s.r.o. is the sole manufacturer of JetSurf brand motorized surfboards.

JetSurf Li-Ion battery technology is provided by Sony Energy Devices Corporation and complies with multiple regulations and standards of transportation including those of:

- International Air Transport Association (IATA) Dangerous Goods Regulations
- International Civil Aviation Organization
- US Department of Transportation

Sony Energy Devices Corporation certifies that the battery technology utilized in JetSurf products has been tested and fulfills the requirements and conditions in accordance with UN Recommendations (T1 – T8) on the Transport of Dangerous Goods Model Regulations and the Manual of Tests and Criteria and can be treated as “Non-Dangerous Goods”.

Please see PDF from Sony Energy Devices Corporation which clearly states the above in greater detail.

All batteries are housed within an ICU which provides an additional metal, water tight enclosure.

Battery amp hour and voltage is clearly marked on each ICU (please see image below).

Regarding the fuel system for all JetSurf products:

- all JetSurf motors are single cylinder 2 stroke engines
- lubrication is not provided by oil encased within the motor (as with 4 stroke engines)
- lubrication is provided by oil that is pre-mixed with the fuel before filling the fuel tank
- **all fuel lines/fuel tanks are removed** from the engines/engine compartments before being packed and shipped via commercial aircraft leaving the engine/engine compartment completely devoid of fuel

It may also be useful to note that JetSurfs have been commercially produced for 8 years. To date, over 4,000 JetSurfs have been manufactured and flown to customers in many countries around the world.

Our customers truly love their JetSurfs and regularly fly with them on vacations etc. Hundreds more JetSurfs are flown to the race locations of the MotoSurf World Cup Championship Series that has taken place in Europe, Asia and North America for the last 5 years.

I trust this provides all necessary clarifications.

Sincerely,

Zbynek Bures
Technical Director
JetSurf - MSR Engines s.r.o. www.msringines.eu

JetSurf - MSR Engines s.r.o. - Made in Czech Republic - Strelce 864, Strelce 664 47
www.jetsurf.com

JETSURF OWNER'S AGREEMENT ORIGINAL

I

Print First and Last Name

agree NOT to undertake any of the following actions and understand that doing so will void and nullify the JetSurf™ Warranty.

I WILL NOT

- 1) Transport the JetSurf™ board with the fuel tank inside.
- 2) Allow any large objects to come into contact with a running engine or spinning turbine
- 3) Attempt to stop a running engine with any tools or part(s) of the human body.
- 4) Interfere with the engine's construction.
- 5) Use the ICU other than the one provided by the manufacturer to operate the engine.
- 6) Use a charger other than which is specified by the manufacturer.
- 7) Charge the battery while the engine is running.
- 8) Charge the battery when the ICU is ON (indicator flashing)
- 9) Charge the battery when the engine is in water.
- 10) Allow water to enter the charger connector.
- 11) Use the charger if it the power cable is mechanically damaged.
- 12) Start the engine with the spark plug cap removed.
- 13) Attempt to start the engine while charging.
- 14) Ride or attempt to ride the JetSurf™ without appropriate safety equipment including Helmet and Life Vest. The use of an arm or leg leash is compulsory and must be used at all times.
- 15) Allow any Third Party or Persons to use the JetSurf™ without prior instruction and training in correct use and operational risks.
- 16) Operate JetSurf™ under the influence of Alcohol, Drugs or when suffering from any physical or mental incapacitation which may affect control of normal bodily faculties.
- 17) Use in shallow, rocky or unfamiliar waters or without surveying and assessing waters for obstructions and obstacles prior to use.
- 18) Violate any provision of this User Manual

THE WARRANTY DOES NOT APPLY TO:

- Normal operational wear and tear.
- Damage caused by accidents.
- Damage caused by using low-quality, incorrect or improperly mixed fuel.
- Damage caused by use of non-original spare parts and accessories.
- Damage caused by foreign objects, debris, sand, mud, dirt or other objects or large particles
- Damage caused by improper use, for example jumps.

I have read and understand these terms and conditions and I am aware that taking ANY of the above steps will void and nullify the JetSurf™ warranty.
I have completed training conducted by an Authorized Dealer and understand what steps must be undertaken to ensure the JetSurf™ board(s) are maintained, cared for, serviced and stored. During this training no imperfections were found on the JetSurf™ product.

MOTORIZED SURFBOARD MODEL:

ADVENTURE DFI RACE DFI

Craft Identification Number (CIN):

Engine - Serial Number (SN):

Seller:

Board Owner Name:

Address:

City, State/Province, Code:

E-mail:

Purchase Date:

Year:

Month:

Day:

Signature of Board Owner:

Signature of Seller:

Person:

Handover date:

Handover place:

version 19-DFI002/EN

JETSURF OWNER'S AGREEMENT COPY

I

Print First and Last Name

agree NOT to undertake any of the following actions and understand that doing so will void and nullify the JetSurf™ Warranty.

I WILL NOT

- 1) Transport the JetSurf™ board with fuel inside the fuel tank.
- 2) Allow any large objects to come into contact with a running engine or spinning turbine
- 3) Attempt to stop a running engine with any tools or part(s) of the human body.
- 4) Interfere with the engine's construction.
- 5) Use the ICU other than the one provided by the manufacturer to operate the engine.
- 6) Use a charger other than which is specified by the manufacturer.
- 7) Charge the battery while the engine is running.
- 8) Charge the battery when the ICU is ON (indicator flashing)
- 9) Charge the battery when the engine is in water.
- 10) Allow water to enter the charger connector.
- 11) Use the charger if it the power cable is mechanically damaged.
- 12) Start the engine with the spark plug cap removed.
- 13) Attempt to start the engine while charging.
- 14) Ride or attempt to ride the JetSurf™ without appropriate safety equipment including Helmet and Life Vest. The use of an arm or leg leash is compulsory and must be used at all times.
- 15) Allow any Third Party or Persons to use the JetSurf™ without prior instruction and training in correct use and operational risks.
- 16) Operate JetSurf™ under the influence of Alcohol, Drugs or when suffering from any physical or mental incapacitation which may affect control of normal bodily faculties.
- 17) Use in shallow, rocky or unfamiliar waters or without surveying and assessing waters for obstructions and obstacles prior to use.
- 18) Violate any provision of this User Manual

THE WARRANTY DOES NOT APPLY TO:

- Normal operational wear and tear.
- Damage caused by accidents.
- Damage caused by using low-quality, incorrect or improperly mixed fuel.
- Damage caused by use of non-original spare parts and accessories.
- Damage caused by foreign objects, debris, sand, mud, dirt or other objects or large particles
- Damage caused by improper use, for example jumps.

AUTHORIZED DEALERS

For service and ordering spare parts please contact FIRST YOUR AUTHORIZED DEALER!

DEALER NAME	STATE/AREA	PHONE	E-MAIL
JetSurf Brasil	Brasil	+55 (41) 9 8836 0361	jetsurfbrasil@jetsurfbrasil.com.br
JetSurf Korea	South Korea	+82 104 493 49 83	korea@jetsurf.com
Aqua Marine - Beaulieu sur Mer	France	+33 644 255 320	sebastiencarignano@aquamarine.fr
Corporental Technogroup	Ukraine	+380 612 242 520	ukraine@jetsurf.com
Deramar	Greece	+30 210 80 70 775	info@deramar.com
Ecolution	Slovakia	+421 905 383 956	info@jetsurf.sk
GS Sport Group	Russia	+7 903 720 99 87	info@jet-surf.su
H2O Leisure Group	United Kingdom	+44 771 362 62 06	matt@h2oleisuregroup.com
Holland Sport Boat Centre	Netherlands	+31 20 694 75 27	info@hollandsport.nl
Jet Surf Trading UG	Germany	+49 151 425 904 83	jetsurfkaufendeutschland@outlook.de
Jetsurf Colombia	Colombia	+57 304 406 33 69	matgo05@hotmail.com
Jetsurf Israel	Israel	+972 54 2042585	Info@jetsurfisrael.com
JetSurf Japan	Japan/Kanagawa	+81 45 514 3018	info@jetsurf-japan.com
Jetsurf Kuwait	Kuwait	+96 566 825 977	info@jetsurfkw.com
Jetsurf Mexico	Mexico	+52 (1) 998 849 4443	Info@jetsurfmxico.com
JetSurf Norway	Norway	+47 480 104 10	info@jetsurf-norway.no
Jetsurf Singapore - Bro & Bro Pte Ltd	Singapore	+65 9889 8776	singapore@jetsurf.com
JetSurf Toronto	Canada/Ontario	+1 416 908 7401	toronto@jetsurf.com
JetSurf USA	USA/Florida	+1 305 538 7873	usa@jetsurf.com
MAREMOTO S.A.S.	Italia	+39 0103776741	info@maremoto.net
Nextwave Yachting - China	China	+86 157 7928 8888	info@nextwaveyachting.com
Nextwave Yachting - Hong Kong	Hong Kong	+852 3188 9787	info@nextwaveyachting.com
Ninety Nine Inter	Thailand	+66 839 030 202	info@mrboatman.net
Race Tool	CZ/Praque	+420 777 026 292	pavel@racetool.cz
JetSurf Hradec Králové	CZ/ H. Králové	+420 603 837 839	fr.novotny@seznam.cz
Jetsurf Costa del Sol	Spain/Costa del Sol	+34 669 13 11 53	info@jetsurfcostadelsol.es
Surfing Motors	Spain/Alicante	+34 676 349 474	spain@jetsurf.com
Take Off Ibiza	Spain/Ibiza	+34 649 66 70 71	info@takeoffibiza.com
Jetboarding+BC,+S.L.	Spain/Malaga	+34 604252498	info@jetboardbarcelona.com
Nauti Parts - Head Office & Shop	Spain/Mallorca	+34 971 67 77 30	nautiparts@yahoo.com
JetSurf UAE	UAE	+971 50 687 3414	uae@jetsurf.com
MAREMOTO DI SERGIO MORABITO & C. S.A.S.	Italy/ Liguria region	+39 010 3776741	info@maremoto.net
Electrosurf AB	Sweden/ Stockholm county	+46 (0)70 760 66 24	henrik@swedensnowsports.com
Importaciones HOLAHO Limitada	Chile	+56 9 9327 7522	fhornauer@gmail.com

HEADQUARTERS

INTERNATIONAL Czech Republic, +420 774 60 27 01, info@jetsurf.com
Monday–Friday 8:00–17:00 CET

BORN FOR FUN

www.jetsurf.com