



USER MANUAL

ALL ONLINE USER MANUALS



P007811 version 25-DFI002/EN_partB

model

**JETSURF RACE DFI, JR-B1
JETSURF RACE DFI SL, JR-D1
JETSURF RACE DFI SKI, JR-E1
JETSURF CRUISER DFI , JC-A1, JC-B1**

part

B

SYMBOLS USED



This symbol is used to mark important warnings which are often ignored by the JetSurf users. Please pay due attention to these warnings. You will thus avoid making frequent user mistakes. These warnings are based on the experience of the JetSurf service technicians. Ignoring these warnings may cause permanent damage to the vessel and its parts.

SAFETY WARNING SYMBOL

This is the safety alert symbol. It is used to alert you to potential personal injury hazards. Obey all safety messages that follow the symbol to avoid possible injury or death.



DANGER indicates an imminently hazardous situation which, if not avoided, will result in death or serious injury.



WARNING

WARNING indicates a potentially hazardous situation which, if not avoided, could result in death or serious injury.



CAUTION

CAUTION indicates a potentially hazardous situation which, if not avoided, may result in minor or moderate injury.



NOTICE

NOTICE is used to address practices not related to physical injury. This information could result in damages to the product that are not covered under warranty.

These precaution icons will appear throughout the Owner's Manual.

PLEASE KEEP THIS MANUAL AT A SAFE PLACE AND HAND IT OVER TO A NEW OWNER IF YOU SELL THE JETSURF.

THE MANUAL COMPRISES OF TWO PARTS (Part A and Part B) which form an integral document. The rules and warnings included in one part apply also to the other. Therefore always keep both parts with you.

TABLE OF CONTENTS

SYMBOL USED	2
SAFETY WARNING SYMBOLS	2
ARRANGEMENT OF JETSURF AND IT'S ACCESSORIES IN BOARD BAG	4
LIST OF ACCESSORIES	5
1B DESCRIPTION	6
FUEL TANK	12
EXHAUST	14
CONTROL HANDLE	15
ENGINE STARTER	17
EXHAUST SILENCER	17
IGNITION CONTROL UNIT (ICU)	18
SIGNALLING OF IGNITION CONTROL UNIT (ICU) FAULTS.....	20
INDICATOR	21
ELECTRIC BILGE PUMP	22
ENGINE	23
2B SPECIFICATIONS	24
LIST OF AUTHORIZED DEALERS	25

DESCRIPTION

ARRANGEMENT OF JETSURF AND IT'S ACCESSORIES IN BOARD BAG



NOTICE: If the JetSurf™ is packed in a box, the stand (2), fins (4a, 4b) and the tool bag (5) is packed in the box outside the board bag.

DESCRIPTION

LIST OF ACCESSORIES

<p>1 Board bag - 1 pc</p>	
<p>2 Stand - 1 pc</p>	
<p>3 Charger - 1 pc</p>	
<p>4 4a - Side fins - 2 pc 4b - Main fin- 1pc</p>	
<p>5 5a - Tool bag - 1 pc 5b - Screw. for main fin - Allen Key M4 - 1pc 5c - Screw. for side fins - PH 2x100 - 1pc 5d - Spark plug spanner - 1 pc 5e - Mout. tool for check. spark plug - 1 pc 5f - Spark plug - 1 pc 5g - Engine shut-off key size L (19-20 cm) - 2 pc <i>Possible to order other sizes:</i> <i>S (17-18 cm)</i> <i>M (18-19 cm), XL (20-21 cm)</i> 5h - speed limiter</p>	
<p>6 User manual part A and B Technical certificate</p>	
<p>7 Main fin base guard</p>	
<p>8 Footstrap BASIC - set, Footpad THICK - set</p>	

1B DESCRIPTION

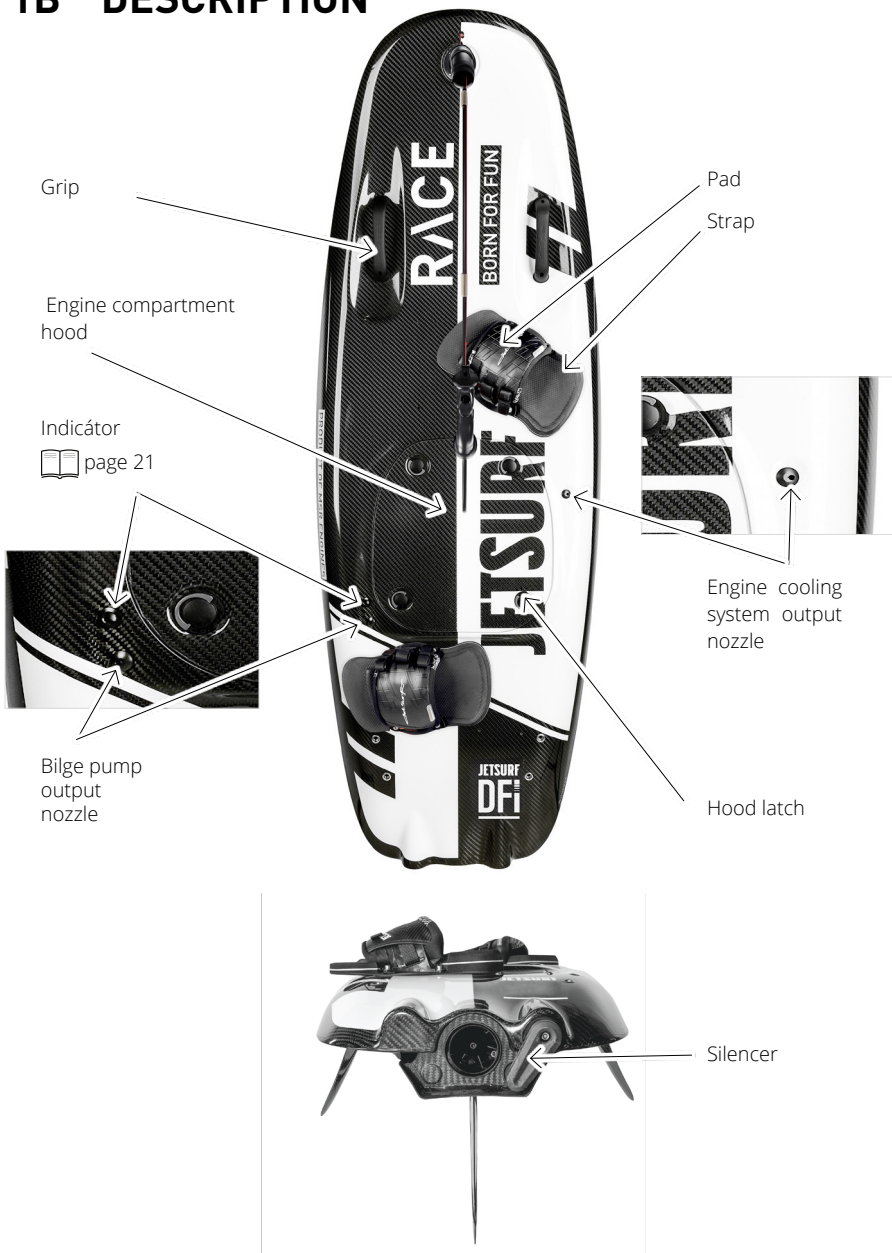

DESCRIPTION

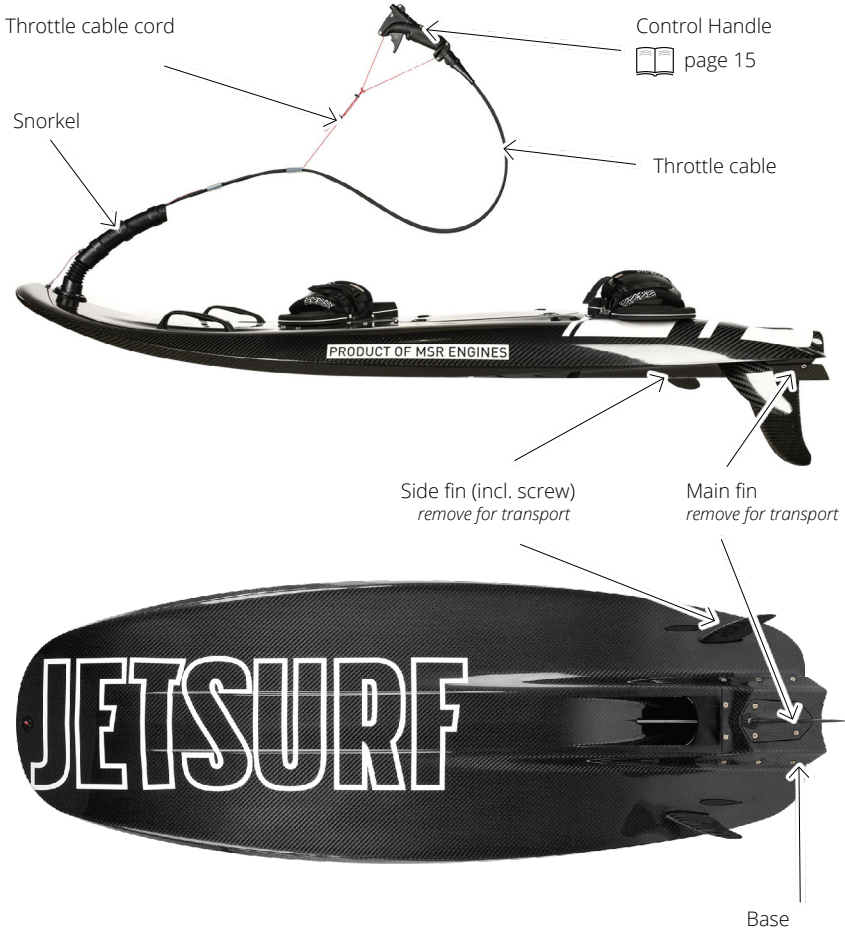

Base



Main fin



Side fin



DESCRIPTION

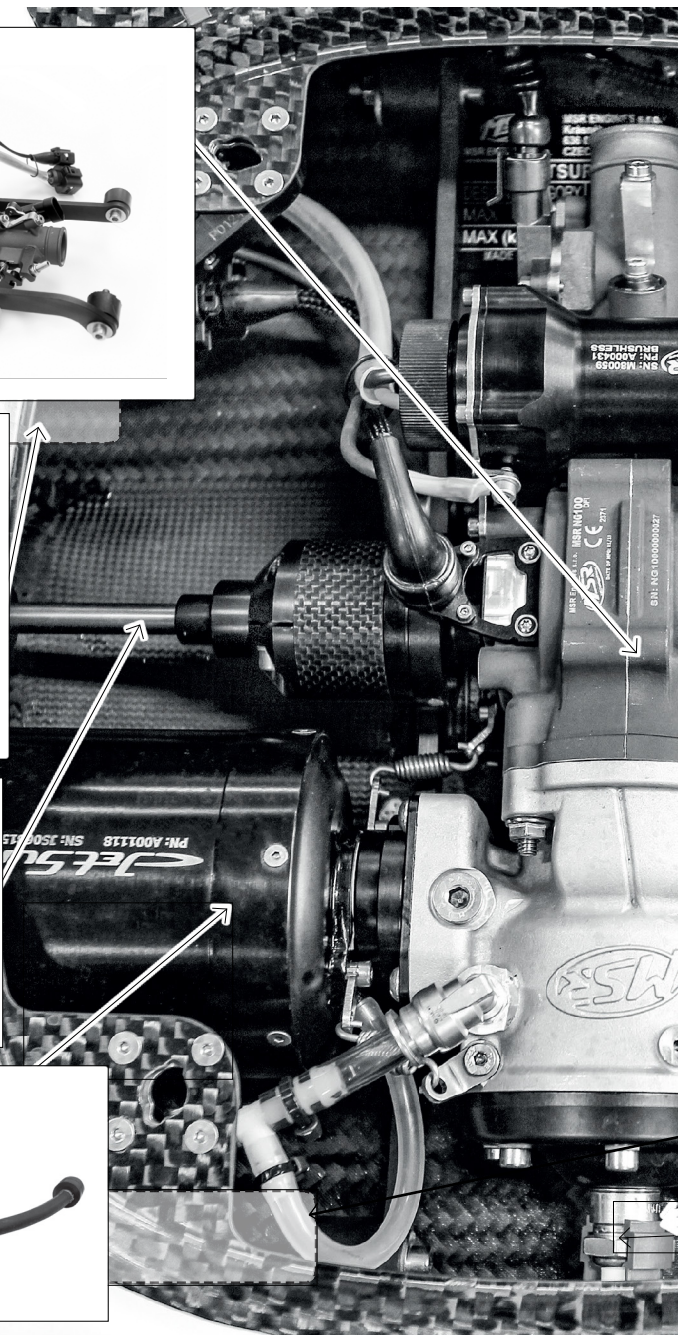
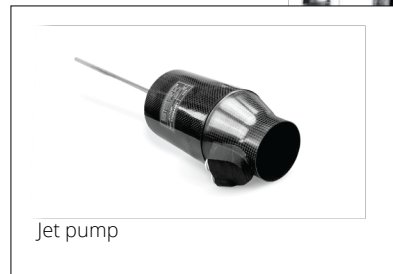
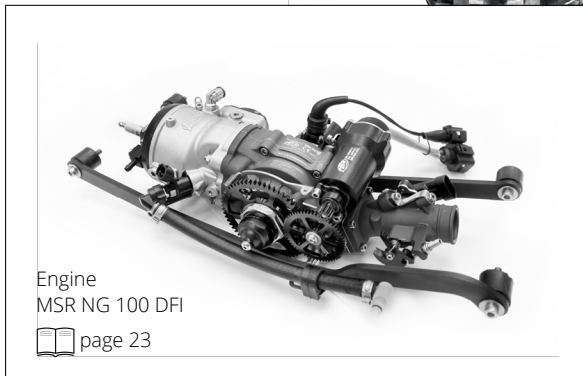

Engine starter



 page 17

Ignition control unit (ICU)
(without a coil)



 page 18

Fuel tank

 page 12



Ignition coil



spark plug



DESCRIPTION

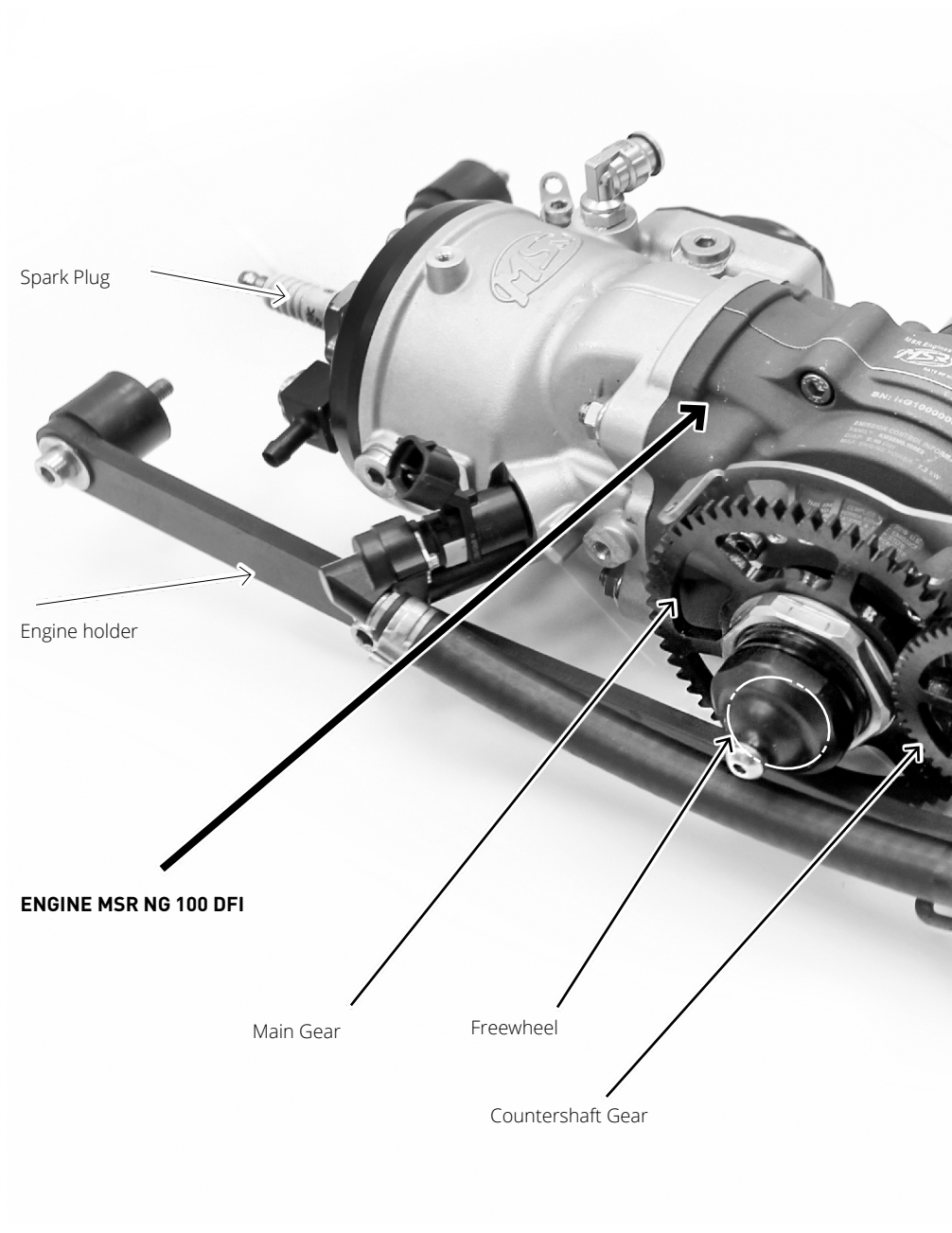

Spark Plug

Engine holder

ENGINE MSR NG 100 DF1

Main Gear

Freewheel

Countershaft Gear

DESCRIPTION

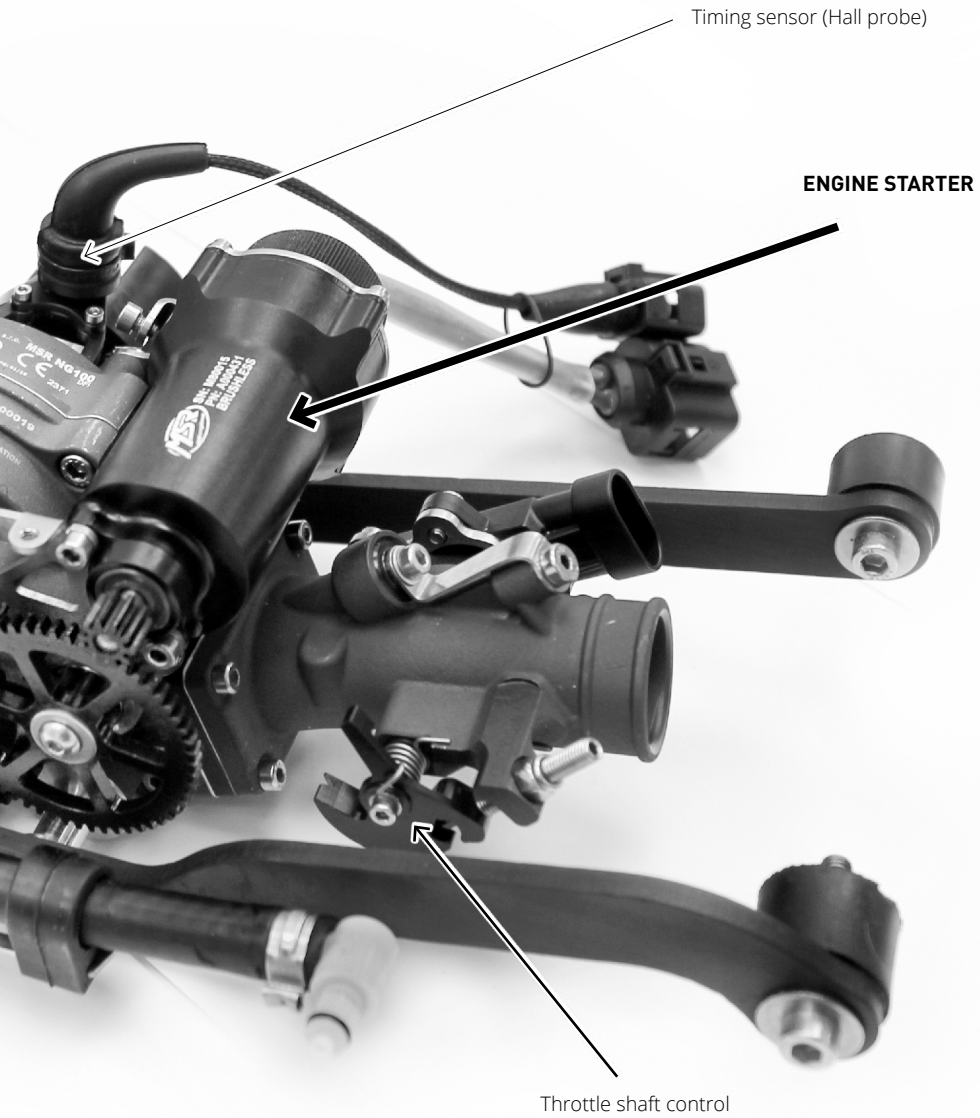

DESCRIPTION

FUEL TANK



NOTICE

Use lead-free car petrol with the octane number 95 or higher mixed in the proportion of fifty (50) parts of fuel to one (1) part of MOTOREX OCEAN FS 2T BIO; or oil meeting these standards: NMMA TC-W3, API TC, ISO-L-EGD: JASO FD/FC; TSI. Bad mixing or use of petrol/oil other than the prescribed one may lead to the engine damage. These cases cannot be covered with the guarantee.

Fuel system consists of the fuel tank, a fuel filter (placed inside of fuel tank), fuel hoses and a fuel pump module. JetSurf™ has venting hose which leads from fuel tank up to the air intake in front part of the board.

The fuel tank can be removed easily by releasing clips (couplings) in the fuel route and disconnect fuel pump connector. (See the instructions specified below in the user manual where you can find complete instructions how to remove the fuel tank correctly).

Using of the correct petrol and oil mixture is crucial for ensuring long-term use of the motorized power board. Using of petrol with an incorrect octane number or oil not meeting the specifications may result in permanent damage to the fuel system and/or the engine which is not covered with the guarantee. **Apart from the above specified, please observe the following measures:**

- MOTOREX OCEAN FS 2T BIO oil can be replaced with a quality fully synthetic oil intended for racing two-stroke engines meeting the standards NMMA TC-W3, API TC, ISO-L-EGD: JASO FD/FC; TSI.
- Never use cheap oil intended for garden machinery or similar mechanical devices.
- **DO NOT USE** synthetic oils intended for use in the engines fuelled by methanol (castor oil)
- Fuel is to be stored only in containers intended for that purpose. Such fuel containers must have D.O.T. approval or CE (for Europe) – specified on the device.
- **DO NOT USE** mixed fuel older than sixty (60) days.
- If it is necessary to remove the fuel from the fuel tank, perform it in a well ventilated area and dispose of it on land. Observe the safety instructions specified in this part of the user manual. Handling of fuel or fuel vapours requires full concentration and correct procedures.
- Never try to suck the petrol up with your mouth. If you swallow some petrol, inhale its vapours or if it gets into your eyes, consult a physician immediately. If petrol gets in contact with your skin, wash the affected place with soap and water. If petrol gets onto your clothes, take them off and let them dry. Wash the clothes after proper drying.

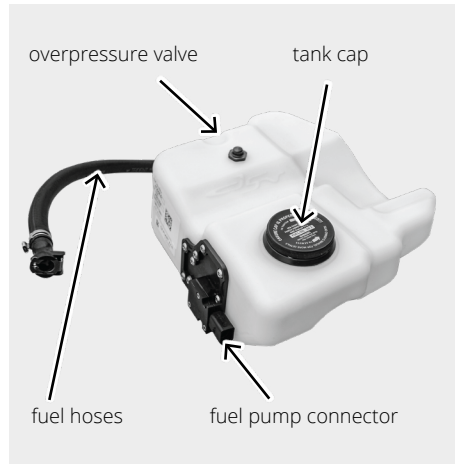

DESCRIPTION

- Check the fuel tank before every ride to make sure that you have enough fuel for the time you have planned to spend on water. If you do not have enough fuel in the tank, your motorized power board might run out of fuel and you can get stuck far from the coast or bank. It is in responsibility of the user to prevent such situations. A low fuel level may also influence the operation. As a result of moving on the water surface, the fuel may flow from side to side in the fuel tank which can lead to uneven fuel distribution into the engine misses. If necessary, always return to land and top up the fuel.
- On such an occasional also check whether there is not water or fragments in the tank. Water stays at the bottom and leaking of water into the tank suggests a problem which has to be solved. Water in the fuel system may cause that the engine will run badly or not at all. Remove the water and destroyed petrol and oil mixture properly and then ask your JetSurf™ sales representative for help in order to find the reason why the water leaked into the tank if it is not an obvious and easily rectifiable cause.
- If it is clear that there are fragments in the fuel tank, do not start the operation of the motorized power board. The fractions might block the fuel system and cause failure of the engine and the user may get stuck far from land. Before starting again, it is important to find out how the fragments got into the fuel system.
- **If you find an obvious damage or leak of the fuel tank or fuel system, DO NOT START THE ENGINE!** Immediately call the authorised dealer of JetSurf™ to assess the fault. Leaking fuel may cause serious damage to the environment and it could be a potential dangerous situation for people and assets.



Petrol is extremely inflammable and highly explosive. Never smoke or handle fire within fifty (50) feet / fifteen (15) metres from the fuel area when topping up fuel. Avoid spilling the fuel. If spilt, dry the fuel with cloth and dispose of it on land. Never start the engine when you can see or smell fuel, as vapours can be more explosive than liquid fuel.

If fuel can be seen during the operation, switch the engine off immediately and find assistance as soon as you get to land. Have the engine and the fuel system repaired by an authorized JetSurf™ seller before restarting the operation.

DESCRIPTION

EXHAUST



DANGER

Carbon monoxide (CO) is a side product of the petrol and petroleum-based oil mixture in the combustion engine. Do not possible to neglect exposure to even a small amount of CO as CO is released from the bloodstream very slowly. CO enters the body through lungs and replaces oxygen in the bloodstream. Physical activity increases the speed with which CO is absorbed in the body. Potential CO poisoning victims should get first aid immediately.

Use only the exhaust system installed by the manufacturer. Replacing of the required exhaust system may result in the engine damage or engine output decrease. The damage caused by using of another system will not be covered with the guarantee.

It is necessary for the users to ensure sufficient cooling of the exhaust system during the operation. It means that the motorized power board must be immersed in water. Running engine longer than 10 seconds outside of the water can result in damage which is not covered with the guarantee and damage of the exhaust system and other engine components.

Even though the JetSurf™ engine produces much fewer side products during combustion than boat engines, exhaust fumes are still generated when the engine is running. These fumes are released by means of the exhaust system under the motorized power board where the carbon monoxide (CO) emissions are produced. Therefore it is necessary to run the engine only when the power board is on water as the fumes will dissolve faster and carbon monoxide resorption will be less probable.

Before every operation check whether the exhaust system has been installed completely and correctly.

DESCRIPTION

CONTROL HANDLE

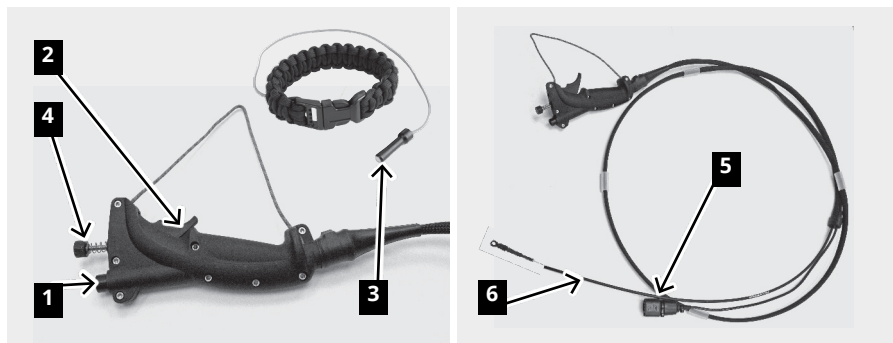

DANGER

The engine shut-off key must be attached to the rider's wrist during the operation. If the rider falls off or is pushed off the motorized power board, the key will be pulled out of the engine shut-off switch and the engine will switch off automatically. It will quickly stop the forward movement of the power board, which not only enables the rider to return to the power board but it also prevents the motorized power board to continue its forward movement, which might lead to its damage, damage to other vessels in its surroundings or injuring any people, including the rider.

DON'T FORGET

NEVER LEAVE THE ENGINE SHUT-OFF KEY INSIDE ENGINE SHUT-OFF SWITCH LONGER THAN 30 SECONDS IF YOU ARE NOT GOING TO CONTINUE IN YOUR RIDE. LEAVING THE ENGINE SHUT-OFF KEY INSIDE HANDLE FOR LONGER PERIOD OF TIME (IE OVER NIGHT OR WHEN TRANSPORTING THE BOARD) CAN LEAD TO COMPLETE DISCHARGE AND NON-REVERSIBLE DAMAGE TO BATTERIES.

The motorized power board is supplied with the control handle which controls the engine output. The handle is supplied together with the engine shut-off key which is used for the power board activation and starting.

It is comprised of:

- Engine shut-off switch (marked 1);
- Throttle trigger (marked 2);
- Engine shut-off key (marked 3);
- Speed limiter (included in the accessories) (marked 4);
- Connector to the ICU (marked 5); and
- Throttle cable (marked 6).

The throttle trigger is situated on the handle, at the end of the throttle cable. JetSurf™ recommends controlling the throttle with your index finger: When the throttle trigger is pressed, you let more fuel in, when it is released, you let less fuel in.

The control handle is equipped with a throttle by means of which the user may decrease the engine power. The throttle is not screwed in the control handle in the factory, it is placed in the bag with accessories. For beginners we recommend screwing the throttle in to 1/3 of its range.

DESCRIPTION

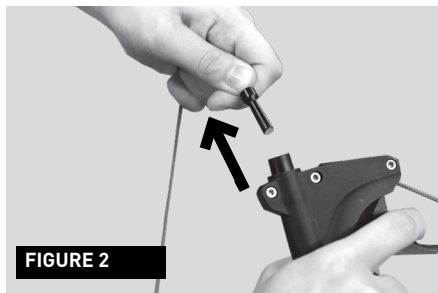

DANGER

It is **ABSOLUTELY NECESSARY** for the rider to release the control handle when he/she loses full control over the board or his/her balance. By pulling the engine shut-off key from the engine shut-off switch you will stop the engine immediately - **FIGURE 1** and **2**. **NOT PULLING THE ENGINE SHUT-OFF KEY FROM THE ENGINE SHUT-OFF SWITCH MAY RESULT IN SERIOUS INJURY OR DEATH.**

Always check it visually and test the connection of the control handle to the throttle control cord by pulling the control handle in order to find out whether there are not any signs of movement.

DESCRIPTION

ENGINE STARTER



Please be aware that excessive use of the starter may result in its overheating and damage.

NEVER START JETSURF IF YOU HAVE WATER IN THE ENGINE (DROWNED ENGINE).



IF THE ENGINE DOES NOT START AFTER THREE (3) ATTEMPTS, CHECK ALL THE BOARD ELEMENTS (HOSES, CONNECTIONS, CONNECTORS, SPARK PLUG...). CHECK WHETHER THERE IS WATER IN THE ENGINE (PAGE 38/PART A OF THIS USER MANUAL). BEFORE STARTING AGAIN, LET THE STARTER COOL DOWN.

EXHAUST SILENCER

The exhaust silencer decreases the noise level significantly.

For its correct function, it is necessary to inspect and clean it regularly. A detailed maintenance description is provided in chapter MAINTENANCE, part A.

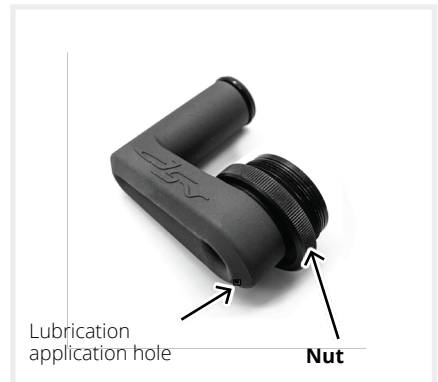

DESCRIPTION

IGNITION CONTROL UNIT (ICU)

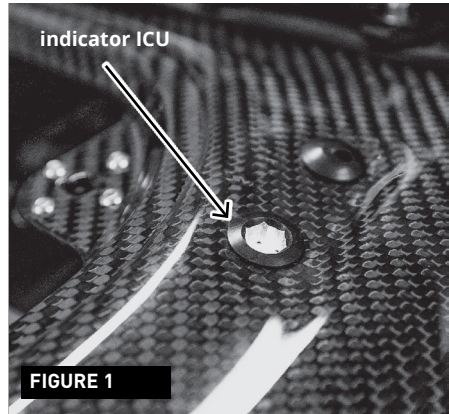

Never try to remove the boot from the spark plug when the ignition control unit (ICU) is connected and in operation (indicator is lit or flashing).

You must never come in contact with the spark plug during the operation or when the motorized power board is in water.



Never try to charge the ignition control unit (ICU) using another charger different from the one specified by JetSurf™. This may result in which permanent dam.

The motorized power board JetSurf™ is equipped with an ignition control unit (ICU). DO NOT USE any other ignition control unit (ICU), than the one specified and supplied by the manufacturer for the engine operation.

The internal battery situated in the ignition control unit (ICU) **MUST BE CHARGED BEFORE EVERY RIDE AND/OR DURING THE RIDES EXCEEDING THE TIME FOR WHICH THE BATTERY CAN STAY CHARGED**. It is necessary to take the motorized power board out of water, dry it out and make the ignition control unit (ICU) accessible for charging.

Internal battery charging is described in detail in chapter RIDE on page 25 / Part A.

The electronic ignition system has six basic states:

- POWER OFF,
- POWER ON (ICU DIAGNOSTICS),
- IDLE (INITIAL STATE),
- RIDE,
- ENGINE CLEARING,
- FAULT.

These states are signalled with a two-colour LED situated on the front of ICU between the conductor bundles. The states and transitions between them are described in the graph XY.

These conditions are signalled by the indicator situated on the board next to the engine cover - FIGURE 1.

DESCRIPTION

POWER OFF – ICU power off

By **BRIEFLY** placing your key to the ICU indicator – FIGURE 2 – you will switch off the ICU. The indicator is not lit or flashing.

ICU DIAGNOSTICS/POWERON– ICU power on

By inserting the key in the switch on the handle – FIGURE 3 – you will switch on the ICU control unit which will perform a battery charge-up test and switch on the electric bilge pump. The LED is lit in red and then orange.

IDLE (INITIAL STATE) – water suction

If you remove the key after switching on the ICU, the ICU will switch over to the IDLE state. If the ICU remains in this state, water is sucked out of the internal area of JetSurf by means of the electric bilge pump. The LED slowly flashes orange.

RIDE

If you place the key again to the switch, the ICU will switch over to the RIDE state. The LED flashes green in variable speed.

ENGINE CLEANING

– removing water or fuel from the engine

The ENGINE CLEANING state is activated whenever the key is placed and left in the position of the circle reading “CLEANING/OFF” – FIGURE 2. Cleaning is finished when you remove the key from the ICU. This function is used to remove water or excess fuel from the engine or sucking fuel from the tank to the carburettor. A detailed description can be found on page 38, part A.

The LED flashes fast in orange.

FAULT

All the faults are signalled with the LED flashing red.

If the key is removed, all the error codes are always signalled three times. If the key is inserted in the handle, the error code signalling is repeated until the key is removed.

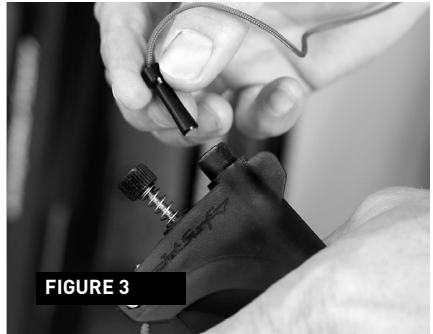



DESCRIPTION

SIGNALLING OF IGNITION CONTROL UNIT (ICU) FAULTS

  The indicator is lit	  The indicator is not lit
--	--

Course of signalling	
Fault type/cause	When the engine shut-off key was inserted in the handle for the first time, it stayed in the handle for longer than 30 seconds.
How to repair it	Pull the key out.

Course of signalling	
Fault type/cause	Low battery – it can be caused by a short circuit of the starter or flat battery.
How to repair it	Charge the battery. Starter replacement – if the batteries are charged and the starter turns slowly.

Course of signalling	
Fault type/cause	Fault of electric bilge pump – a short circuit of the pump has been detected but the ignition works normally after that.
How to repair it	Check the conductor to the pump, clean the pump or replace it.

Course of signalling	
Fault type/cause	Fault of excessive use of the starter – there have been 10 starts without the engine getting started, this signalling will last 2 minutes.
How to repair it	Wait for 2 minutes.

Course of signalling	
When the ignition control unit (ICU) is switched off, it switches off automatically after 5 minutes of idleness.	

DESCRIPTION

INDICATOR

Indicator (FIGURE 1) has several functions:

SIGNALLING:

- Signalling the ride duration
- Signalling the conditions and errors of the ICU control unit

CONTROLLING:

- By **BRIEFLY** placing your key to the indicator you will switch the ICU off and on
- By placing and **LEAVING** the key on the indicator, you will switch on the function "REMOVAL OF WATER AND FUEL FROM THE ENGINE".

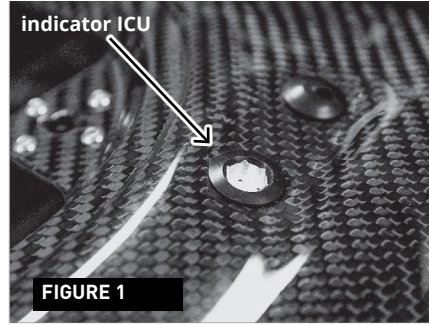

DESCRIPTION OF THE FUNCTION OF THE RIDE DURATION INDICATOR

- 1) Place the key to the indicator
- 2) To up the tank
- 3) Start the JetSurf™ by inserting the key in the control handle
- 4) When riding for the first 20 minutes, the indicator flashes green, then it flashes purple (there is approximately half tank of fuel)

To use the indicator function again, repeat the procedure from item 1.

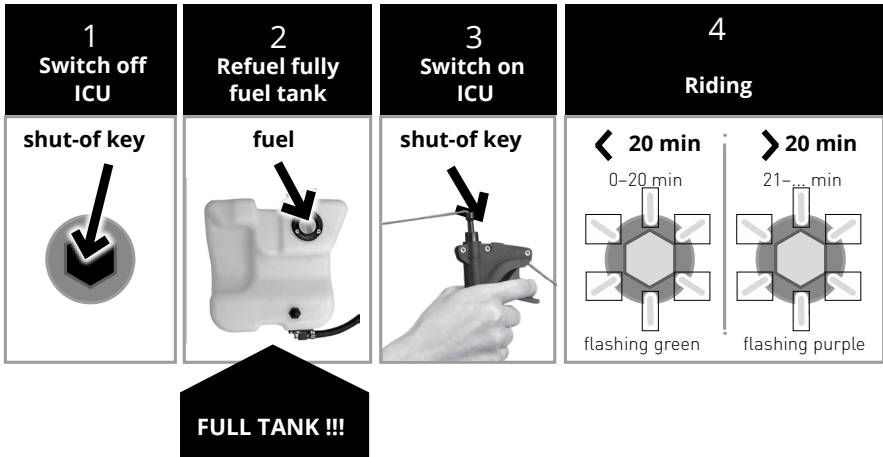

INDICATOR COLOUR MAP

- RED – error state (including power off)
- ORANGE – idle state (power on)
- GREEN – running state (engine is running)
- PURPLE – half of the fuel tank is empty (power off is required)
- WHITE – engine cleaning

DESCRIPTION

ELECTRIC BILGE PUMP

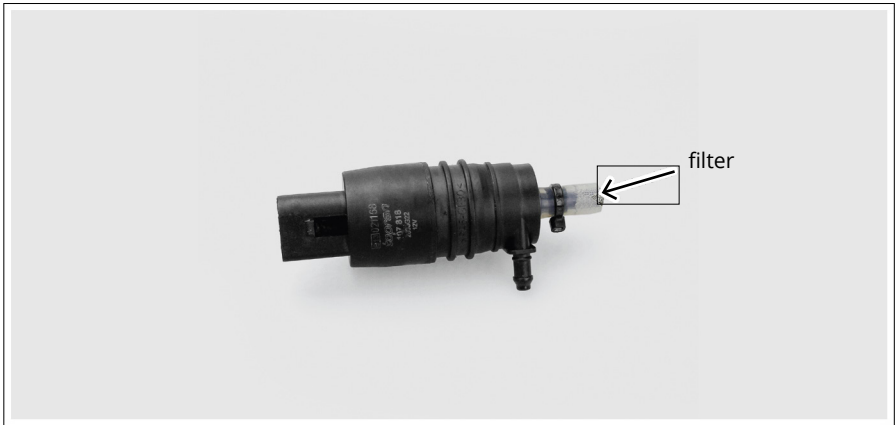

**Please check the function of the bilge pump before every ride and during the ride.
Keep the suction filter clean.**

The bilge pump suck water from the internal area of JetSurf. It is a vital part for the JetSurf operation. During every ride, check whether the pump work properly.

DESCRIPTION

ENGINE

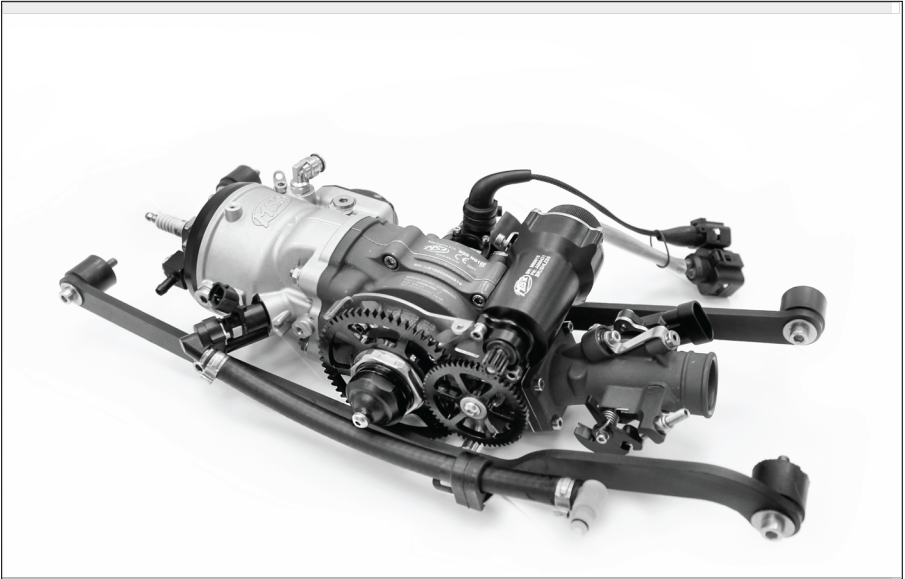

ENGINE MSR NG 100 DFI



Petrol is extremely flammable and highly explosive. Never smoke or handle fire within fifty (50) feet / fifteen (15) metres from the fuel area when topping up fuel. Avoid spilling the fuel. If spilt, dry the fuel with cloth and dispose of it on land. Never start the engine when you can see or smell fuel as vapours can be more explosive than liquid fuel. If fuel is seen during the operation, switch the engine off immediately and seek assistance as soon as you get to land. Have the engine and the fuel system repaired by an authorised JetSurf™ seller before restarting the operation.

Fuel must always be transported only in canisters approved by the D.O.T. organisation or CE (Europe). Transporting fuel in the fuel tank or in the engine may result in damage or injury. Fuel vapours are even more unstable, explosive and generally more dangerous than liquid fuel.

Never try to open the spark plug boot when the ignition control unit (ICU) is connected and in operation (the LED must not be lit or flashing on the ICU). The boot is under high voltage. A contact with it can result in serious injury or death.

DESCRIPTION

2B SPECIFICATIONS

DESCRIPTION	
Overall length (mm)	1 800
Overall width (mm)	600
Overall height (mm)	150
Weight without pad (kg)	19,5
Fuel tank capacity (l)	2,8
Passenger capacity	One operator
Max Rider weight (kg)	100
Category*	D
Cruising range (mins)	55
Max Speed	58 km/h (35 mph)
CONSTRUCTION OF CRAFT	
Hull	100% carbon fibre
ENGINE	
Engine type	2-stroke, 1 cyl
Cooling	Water
Lubrication system	Premixed fuel and oil. Fuel mixing ratio (fuel to oil) 50:1
Petrol	Minimum octane rating (RON) 95, unleaded
Oil	MOTOREX OCEAN FS 2T BIO; or oils meeting these standards: NMMA TC-W3, API TC, ISO-L-EGD: JASO FD/FC; TSI
Mixture preparation	DFI, Digital Fuel Injection
Displacement (cc)	100
Power (kW)	7,2
Idle speed (1/min)	7250
Bore/stroke (mm)	48/49,5
Compression ratio	11:1
Spark Plug:	NGK BPR 7HS
ELECTRICAL	
Ignition	Processor ICU
Starter	3F brushless otor
Battery	Li-Ion 100 Wh (9 Ah); nominal voltage 11,1 V; maximum charging voltage is 12,6 V
DRIVE SYSTEM	
Propulsion system	Direct Jet pump; Axial flow, single stage
Impeller material	Carbon fibre
Nozzle material	Carbon fibre
Jet pump thrust	570 N
Manufacturer	MSR Engines s.r.o.

* – EU DIRECTIVE 2013/53/EU – The definition of Boat Design Category D:

"D. Sheltered waters — Designed for voyages on sheltered coastal waters, small bays, small lakes, rivers and canals when conditions up to, and including, wind force 4 and significant wave heights up to, and including, 0.3 m may be experienced, with occasional waves of 0.5 m maximum height, for example from passing vessels."

AUTHORIZED DEALERS

FIND THE NEAREST AUTHORIZED DEALER OR SERVICE POINT:

Scan this QR code to access our website, where you can find a list of authorized dealers and service centers near you. With an easy-to-use search function, you can select the most suitable option based on your location, whether you need service or want to purchase products.



HEADQUARTERS

INTERNATIONAL Czech Republic, +420 774 60 27 01, info@jetsurf.com
Monday–Friday 8:00–17:00 CET

BORN FOR FUN

www.jetsurf.com